

0 601 148 603

Stand } 00-02-21 **Fig./Abb. 1**

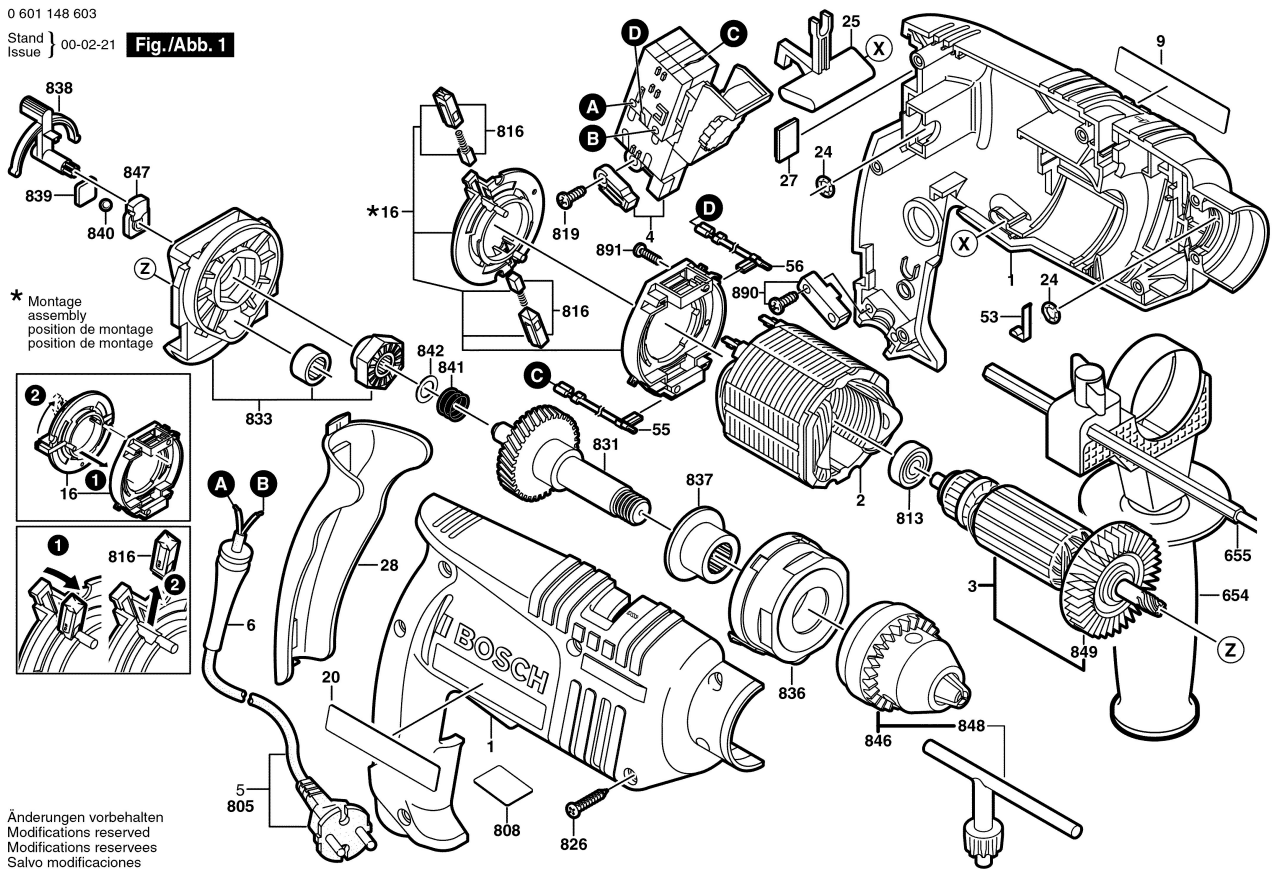

* Montage
assembly
position de montage
position de montage

Änderungen vorbehalten
Modifications reserved
Modifications reserves
Salvo modificaciones