

0 601 375 7A6
 Stand | 08-07
 Issue | 14-07-22

Fig. /Abb. 1

Gerad - Verzahnung

● Vor Demontage des Ankers
 Kohlebürsten 5mm zurückziehen !
 Before the armature is removed the carbon brushes
 must be withdrawn by at least 5mm !

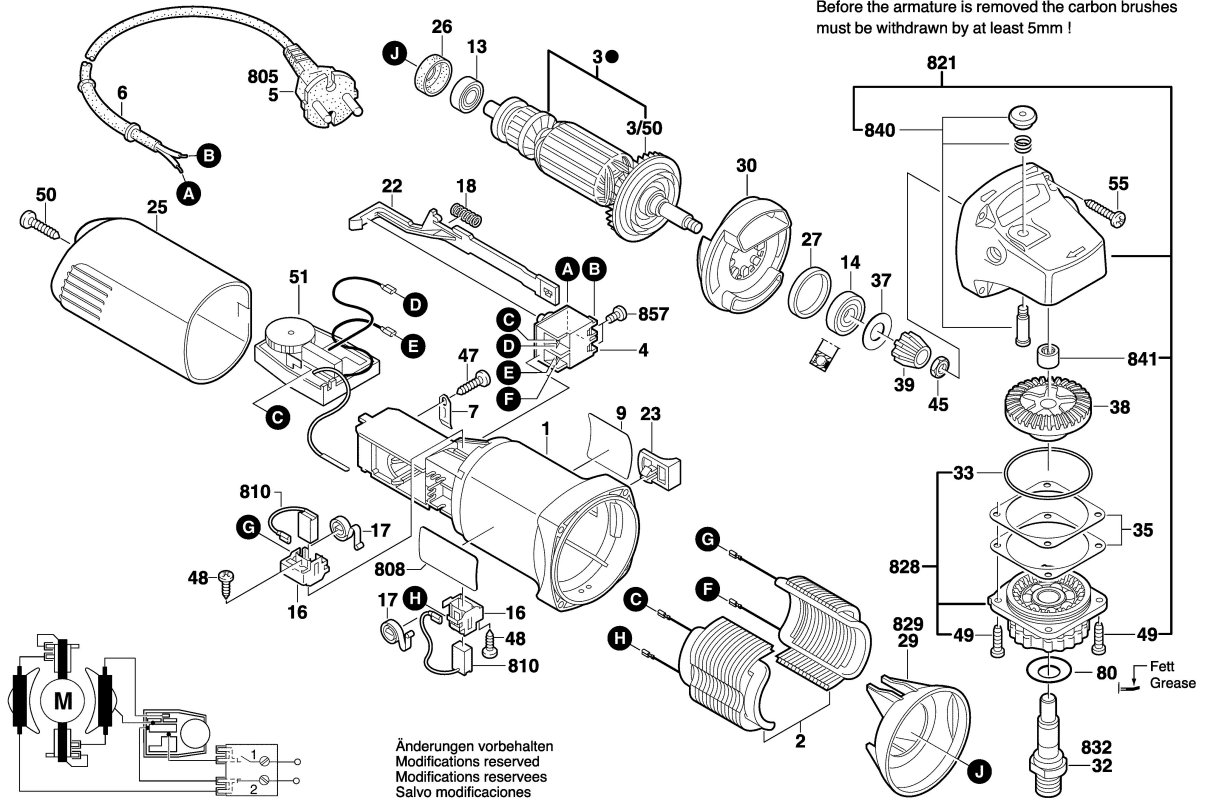

0 601 375 7A6
 Stand | 08-07
 Issue | 09-01-21

Fig. /Abb. 2

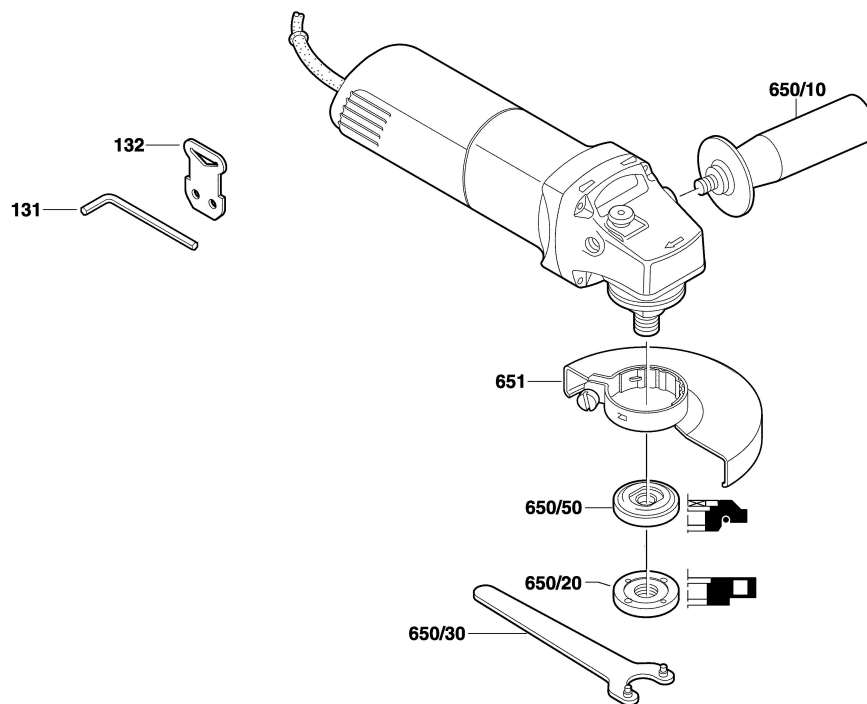

Änderungen vorbehalten
 Modifications reserved
 Modifications reserves
 Salvo modificaciones