

0 601 510 603
 Stand | 08-08
 Issue | 12-12-19

Fig./Abb. 1

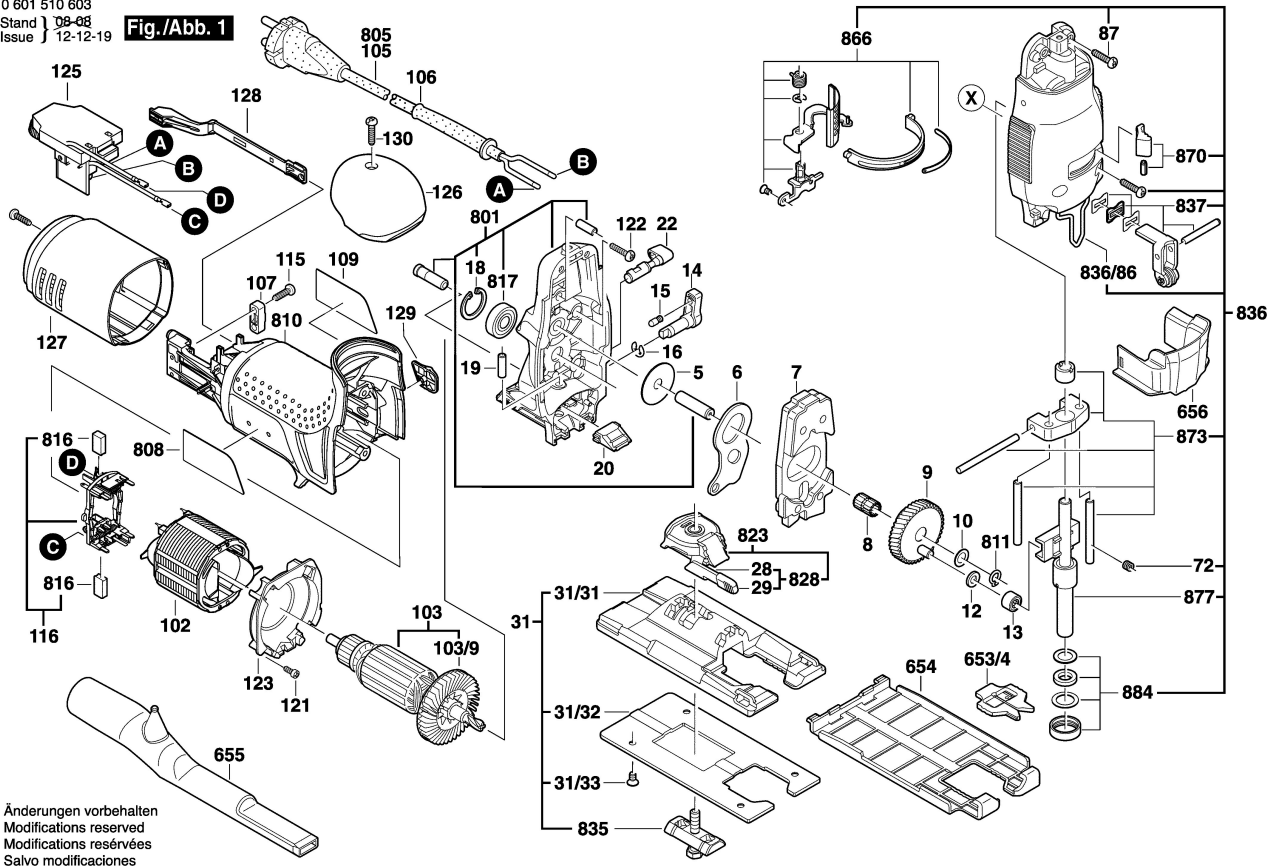

Änderungen vorbehalten
 Modifications reserved
 Modifications réservées
 Salvo modificaciones