

0 601 856 403
 Stand 11-04
 Issue 08-12-05

Fig./Abb. 1

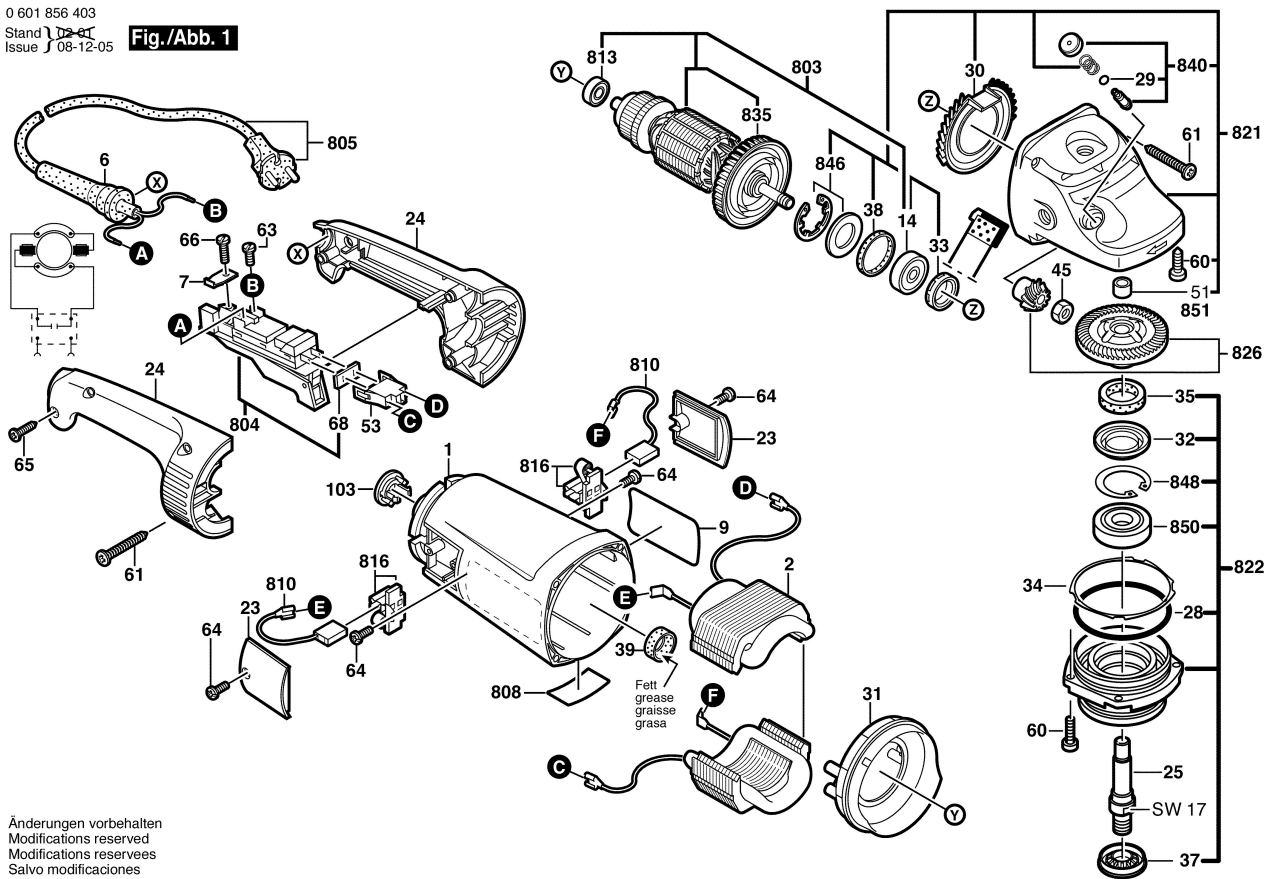

Änderungen vorbehalten
 Modifications reserved
 Modifications reserves
 Salvo modificaciones

0 601 856 403
 Stand 11-04
 Issue 07-12-11

Fig./Abb. 2

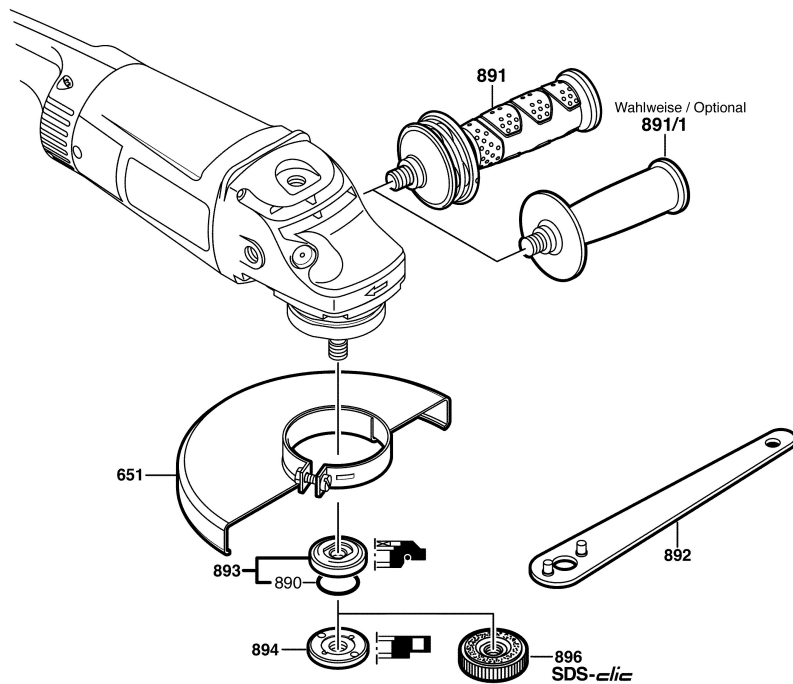

Änderungen vorbehalten
 Modifications reserved
 Modifications reserves
 Salvo modificaciones