

0 603 229 203

Stand Issue J 00-09-26

Fig./Abb. 1

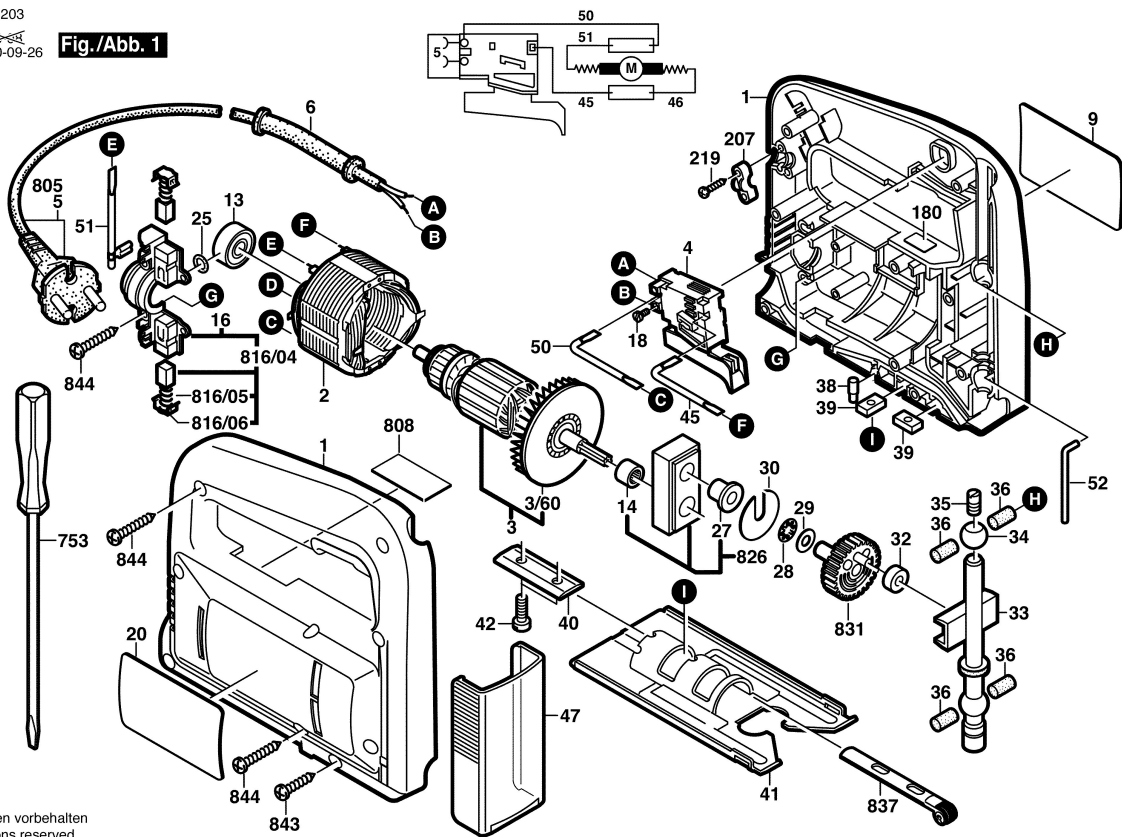

Änderungen vorbehalten
Modifications reserved
Modificaciones reservadas
Salvo modificaciones