

0 603 285 503
Stand 00-06
Issue J 00-07-12

Fig./Abb. 1

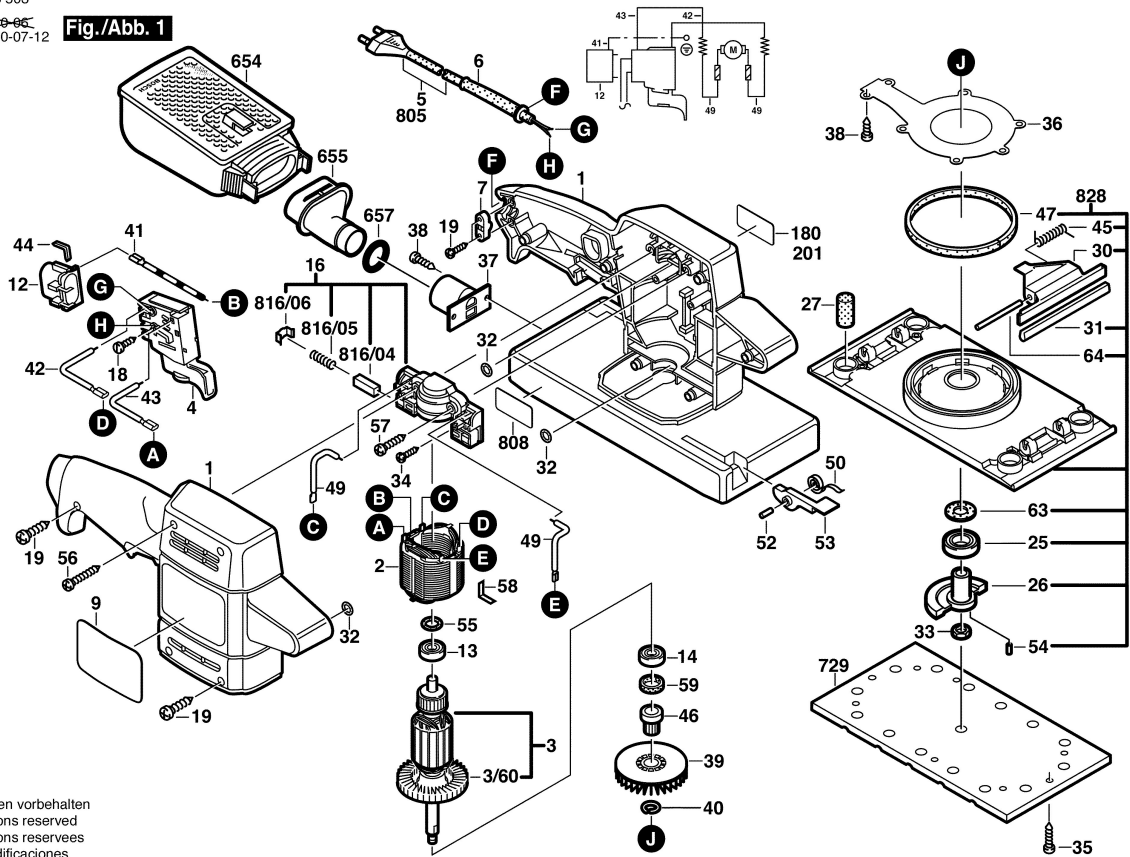

Änderungen vorbehalten
Modifications reserved
Modifications reserves
Salvo modificaciones