

0 603 367 003
 Stand 1 00-03
 Issue J 01-06-18

Fig./Abb. 1

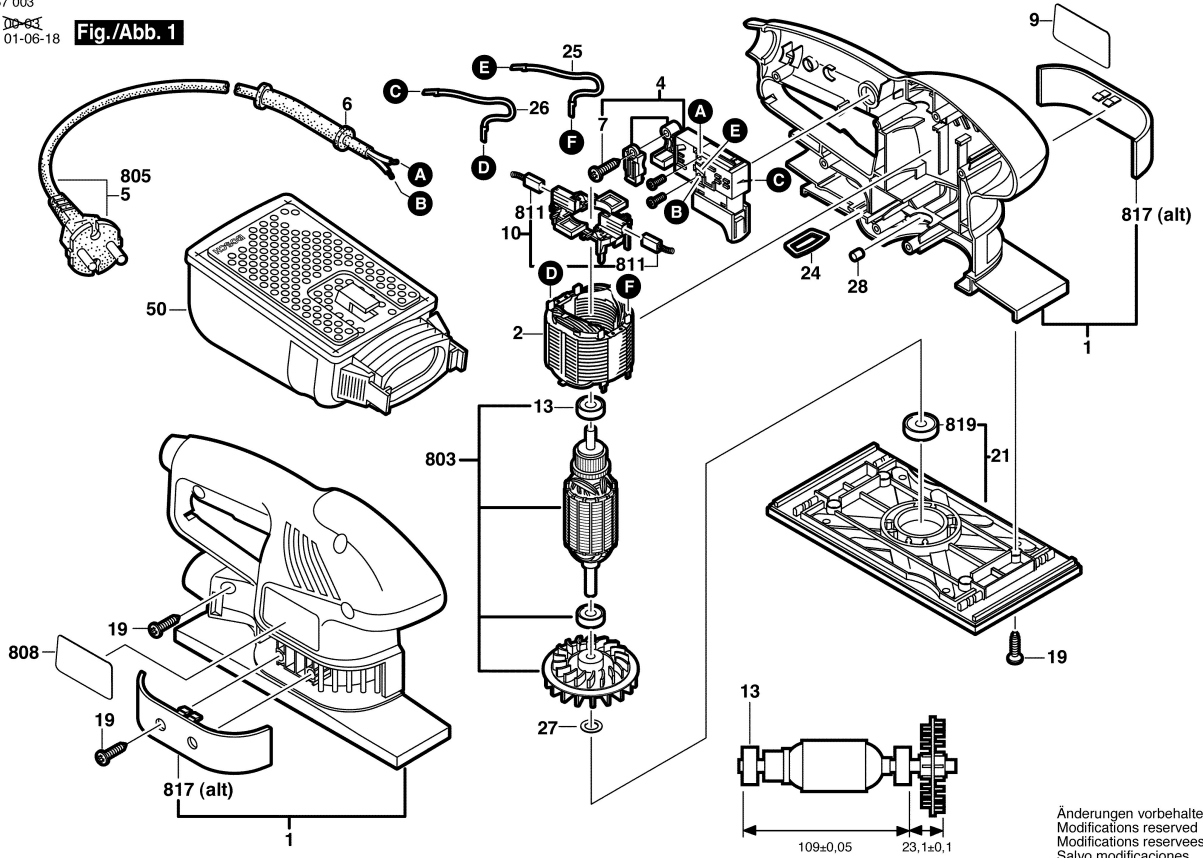

Änderungen vorbehalten
 Modifications reserved
 Modifications reserves
 Salvo modificaciones