

0 603 380 203

Stand Issue 05-03-22

Fig./Abb. 1

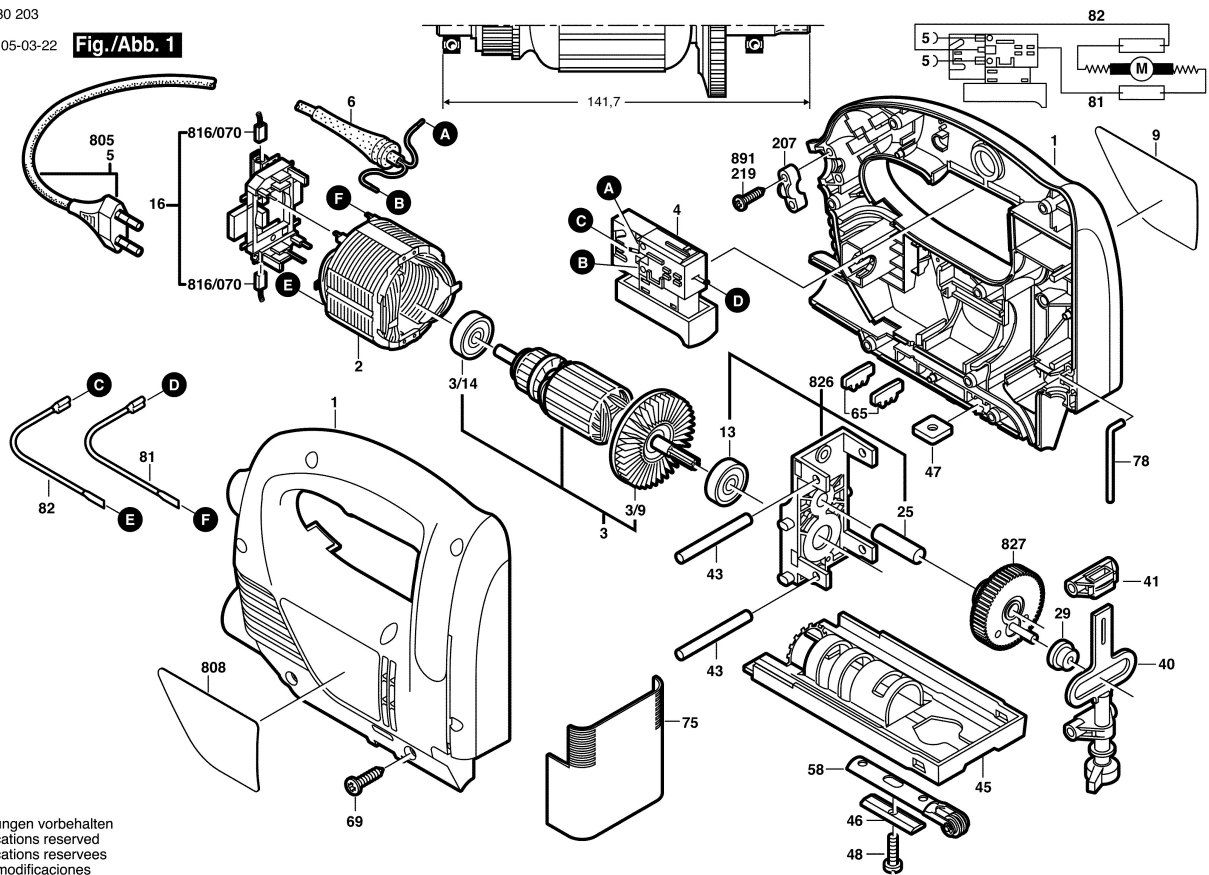

Änderungen vorbehalten  
Modifications reserved  
Modificaciones reservadas  
Salvo modificaciones