

0 603 381 703
 Stand 1 09-81
 Issue J 00-09-12

Fig./Abb. 1

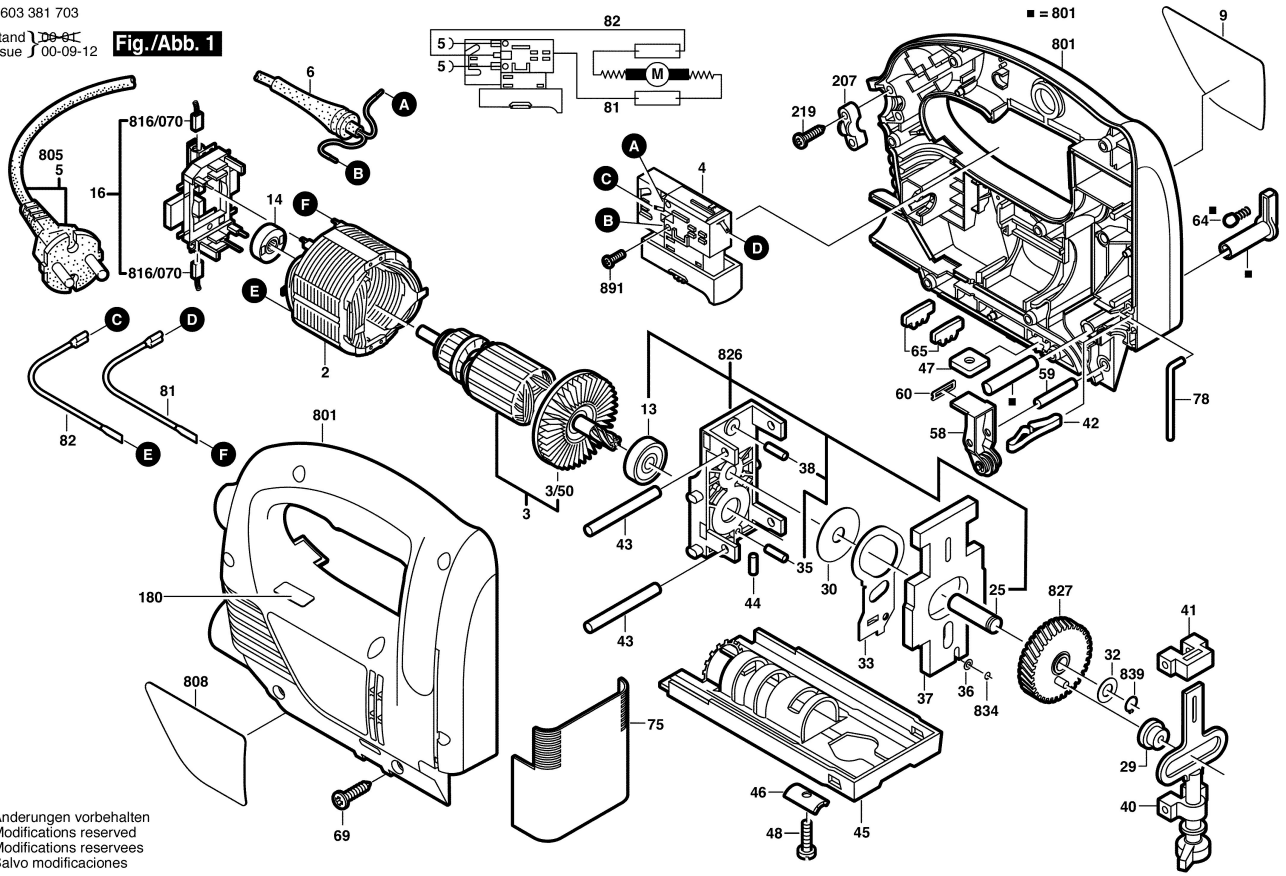

Änderungen vorbehalten
 Modifications reserved
 Modifications reserves
 Salvo modificaciones