

0 603 382 703  
Stand 1 09-04  
Issue J 00-09-12

Fig./Abb. 1

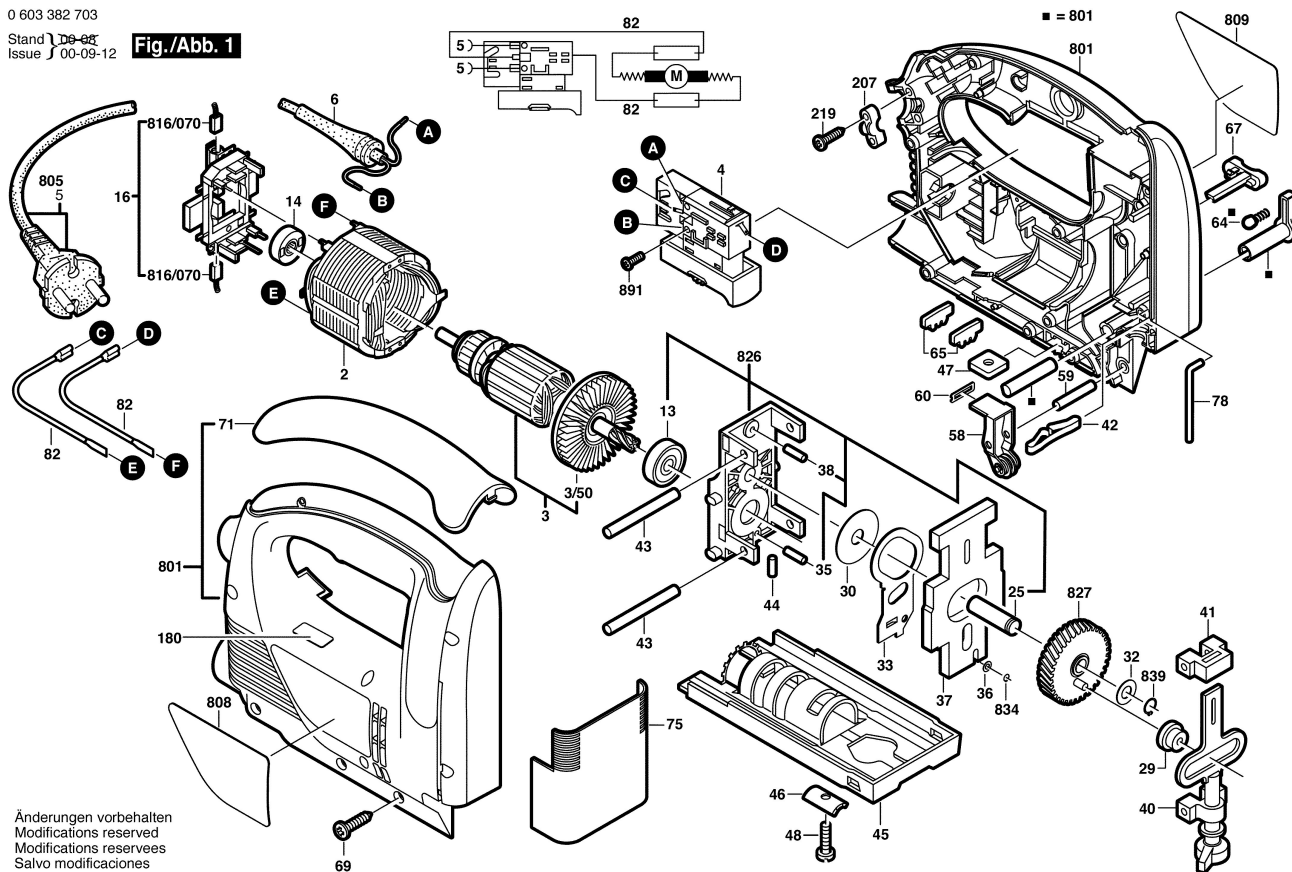

Änderungen vorbehalten  
Modifications reserved  
Modifications reserves  
Salvo modificaciones