

0 603 388 278

Stand Issue 02-08-29

Fig./Abb. 1

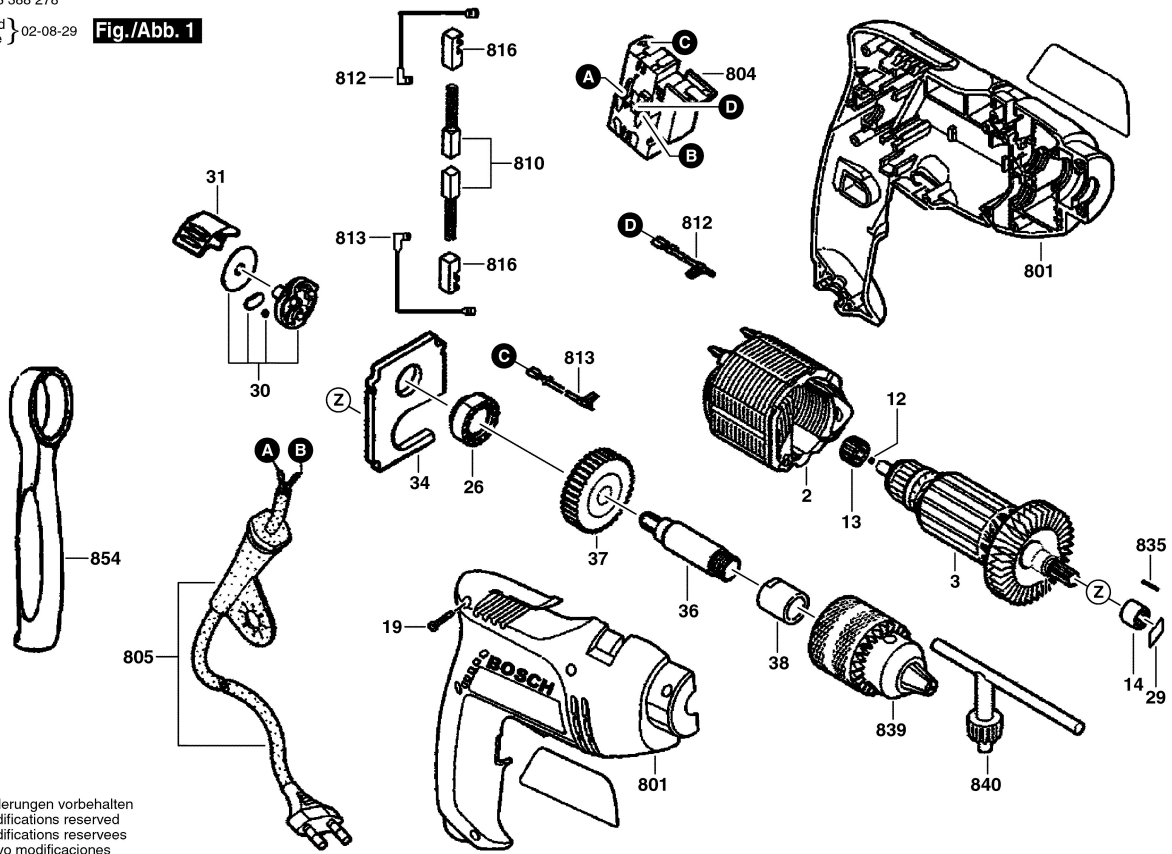

Änderungen vorbehalten
Modifications reserved
Modifications reserves
Salvo modificaciones