

0 603 391 760
 Stand | 02-06
 Issue | 05-10-20

Fig./Abb. 1

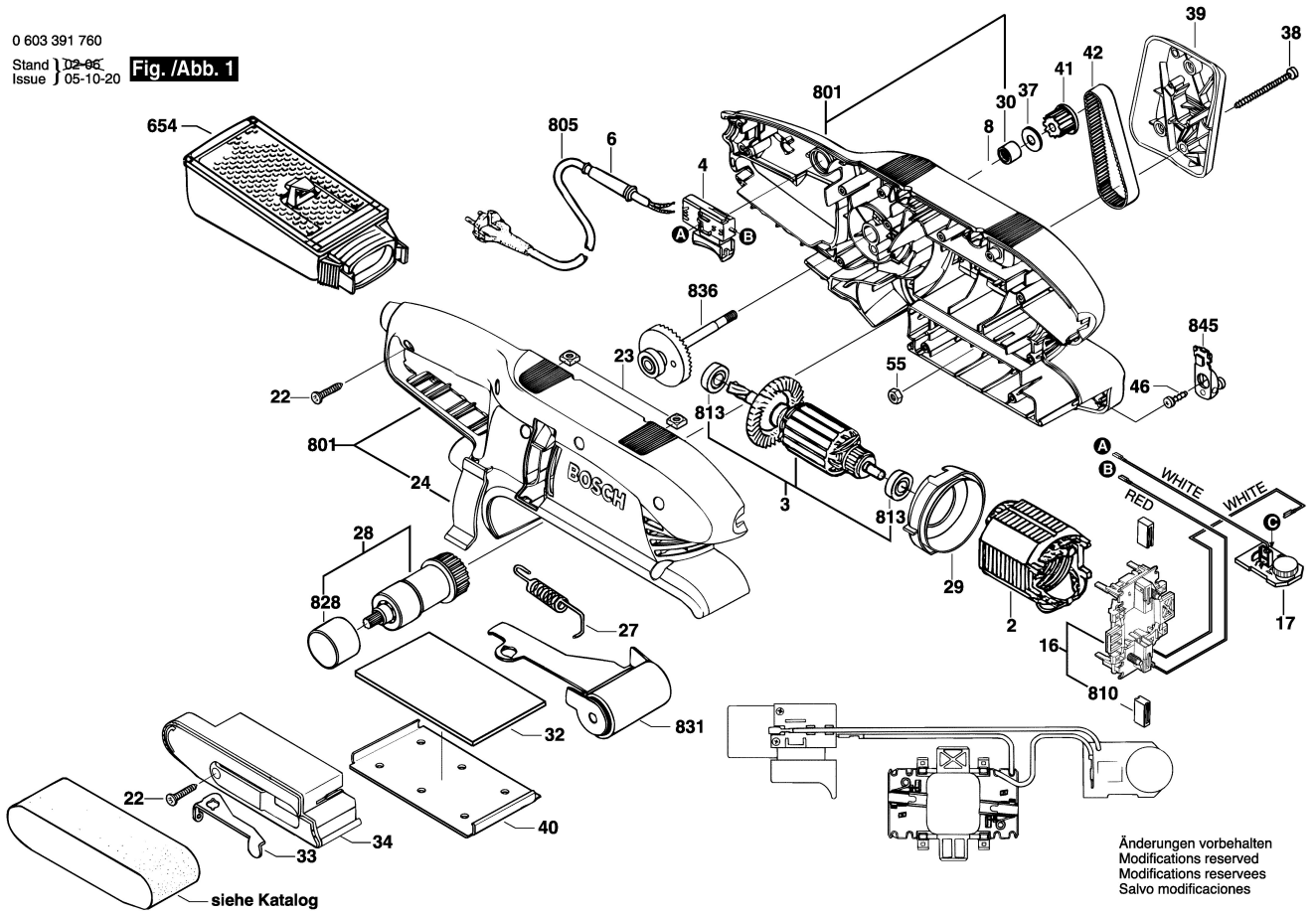

0 603 391 760
 Stand | 05-11
 Issue | 13-12-04

Fig./Abb. 2

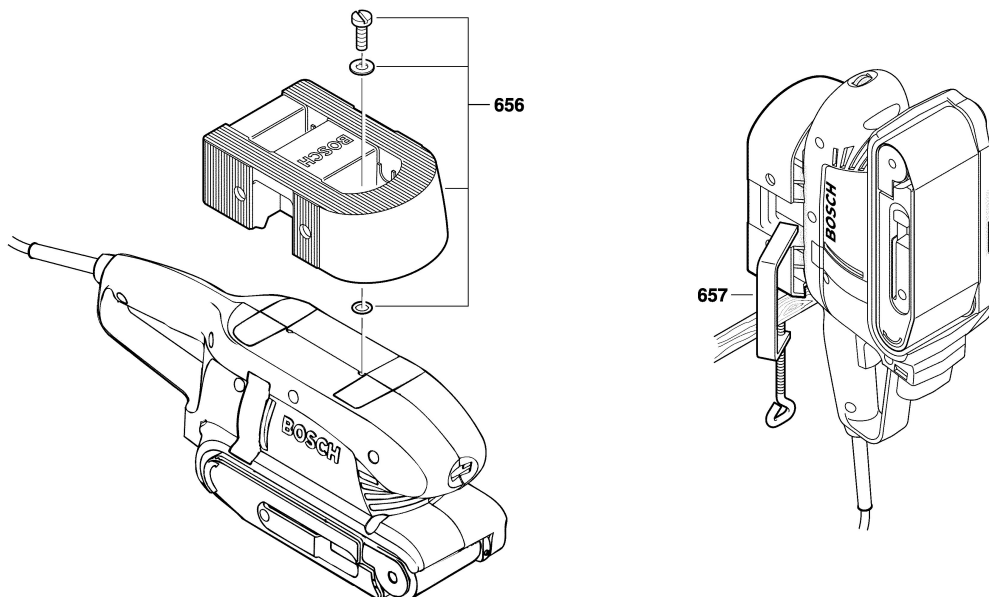

Änderungen vorbehalten
 Modifications reserved
 Modifications reserves
 Salvo modificaciones