

0 603 946 503

Stand } 1-83  
Issue } 01-04-03

**Fig./Abb. 1**

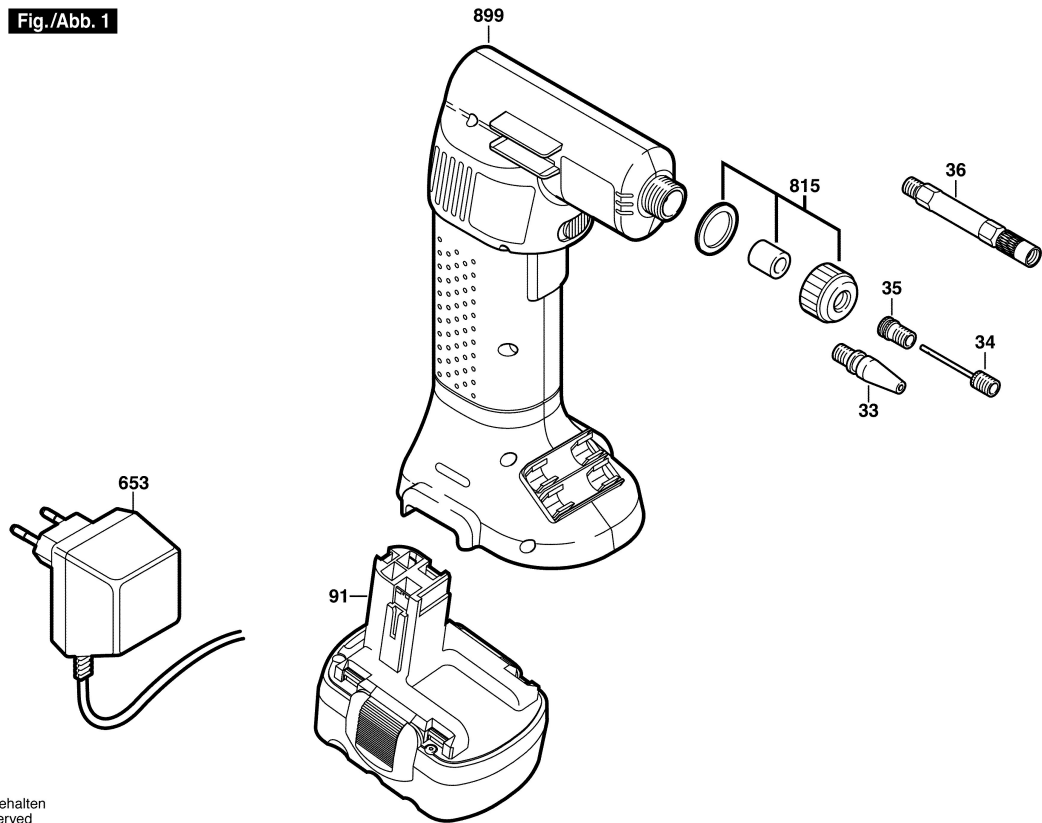

Änderungen vorbehalten  
Modifications reserved  
Modifications reserves  
Salvo modificaciones