

3 600 H34 170

Stand | 10-02
Issue | 11-07-21

Abb. / Fig.

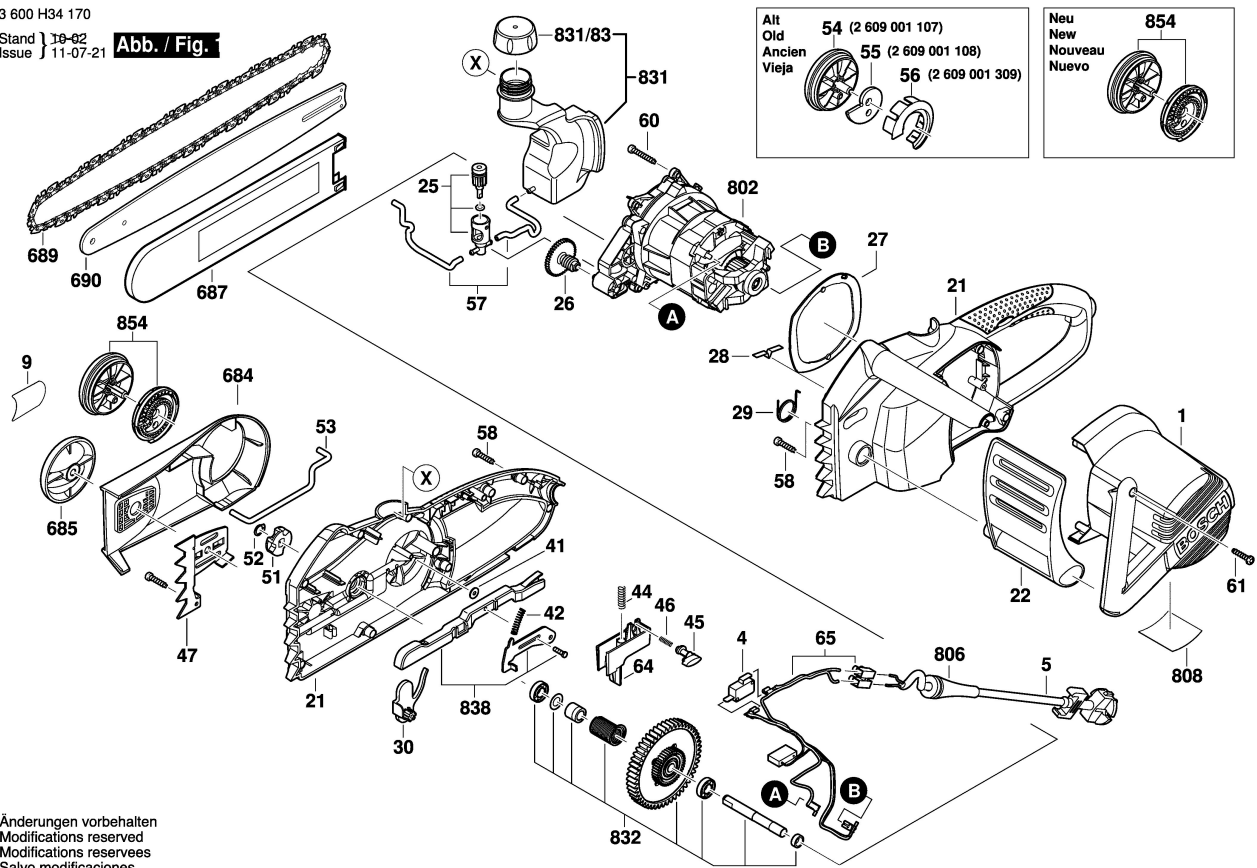

Änderungen vorbehalten
Modifications reserved
Modifications reserves
Salvo modificaciones