

3 601 JD0 2B0
Issue 14-03-26
Stand

Fig./Abb. 1

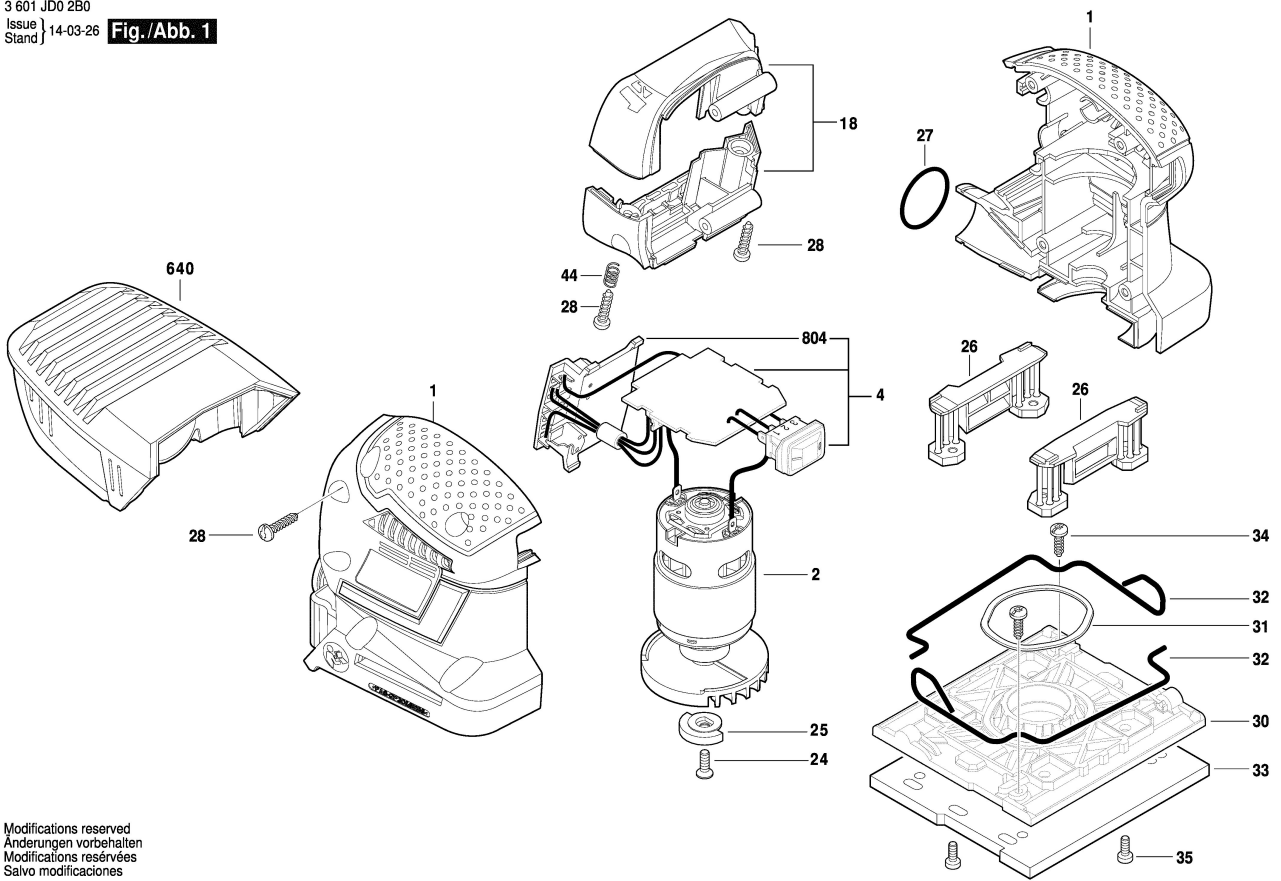

Modifications reserved
Änderungen vorbehalten
Modifications réservées
Salvo modificaciones