

3 601 K66 910
Issue | 09-09-01
Stand |

Fig./Abb. 1

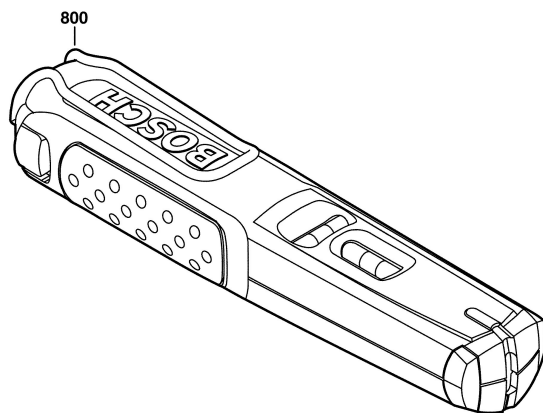

Modifications reserved
Änderungen vorbehalten
Modifications réservées
Salvo modificaciones