

3 601 K72 000
Issue
Stand } 09-07-06

Fig./Abb. 1

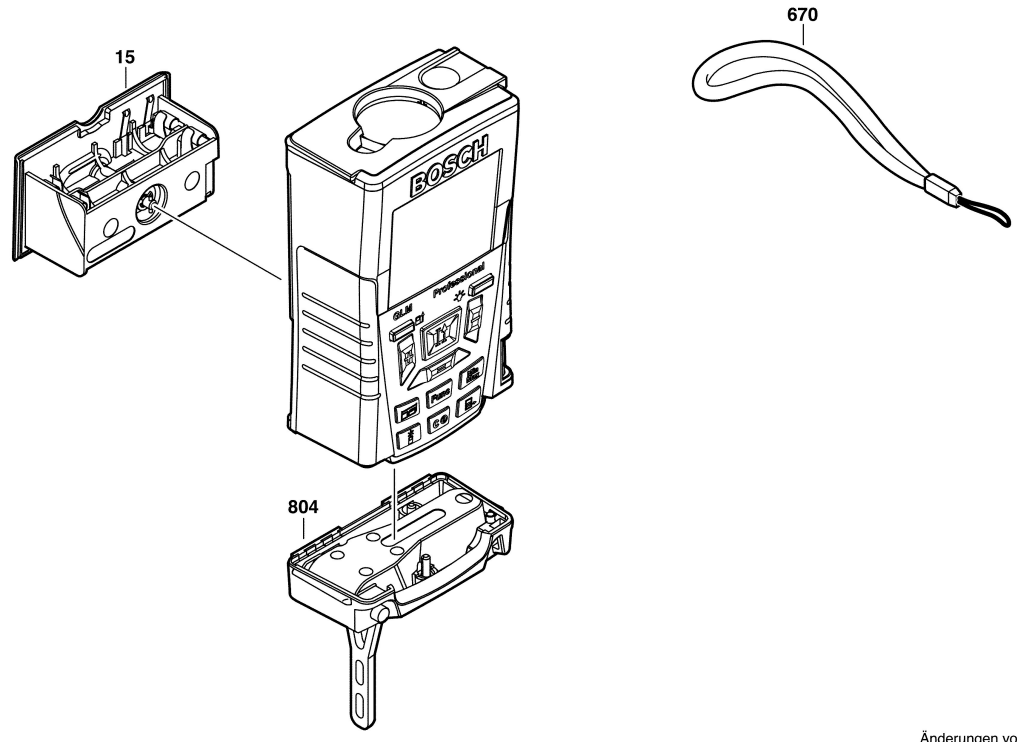

Änderungen vorbehalten
Modifications reserved
Modifications réservées
Salvo modificaciones