

3 601 K72 810
Issue
Stand } 14-04-15

Fig./Abb. 1

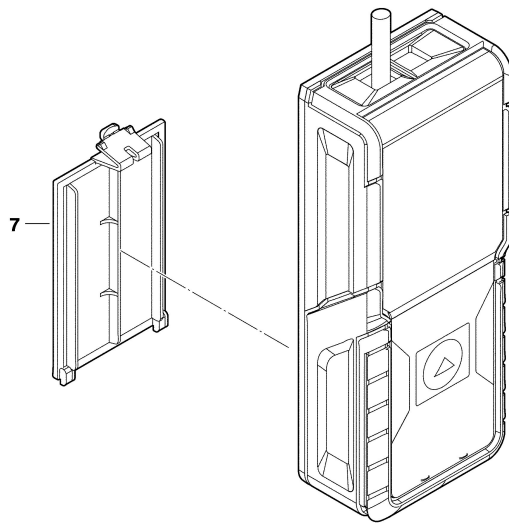

Änderungen vorbehalten
Modifications reserved
Modifications réservées
Salvo modificaciones