

3 601 L17 0E1
Issue 13-04-10
Stand

Fig./Abb. 1

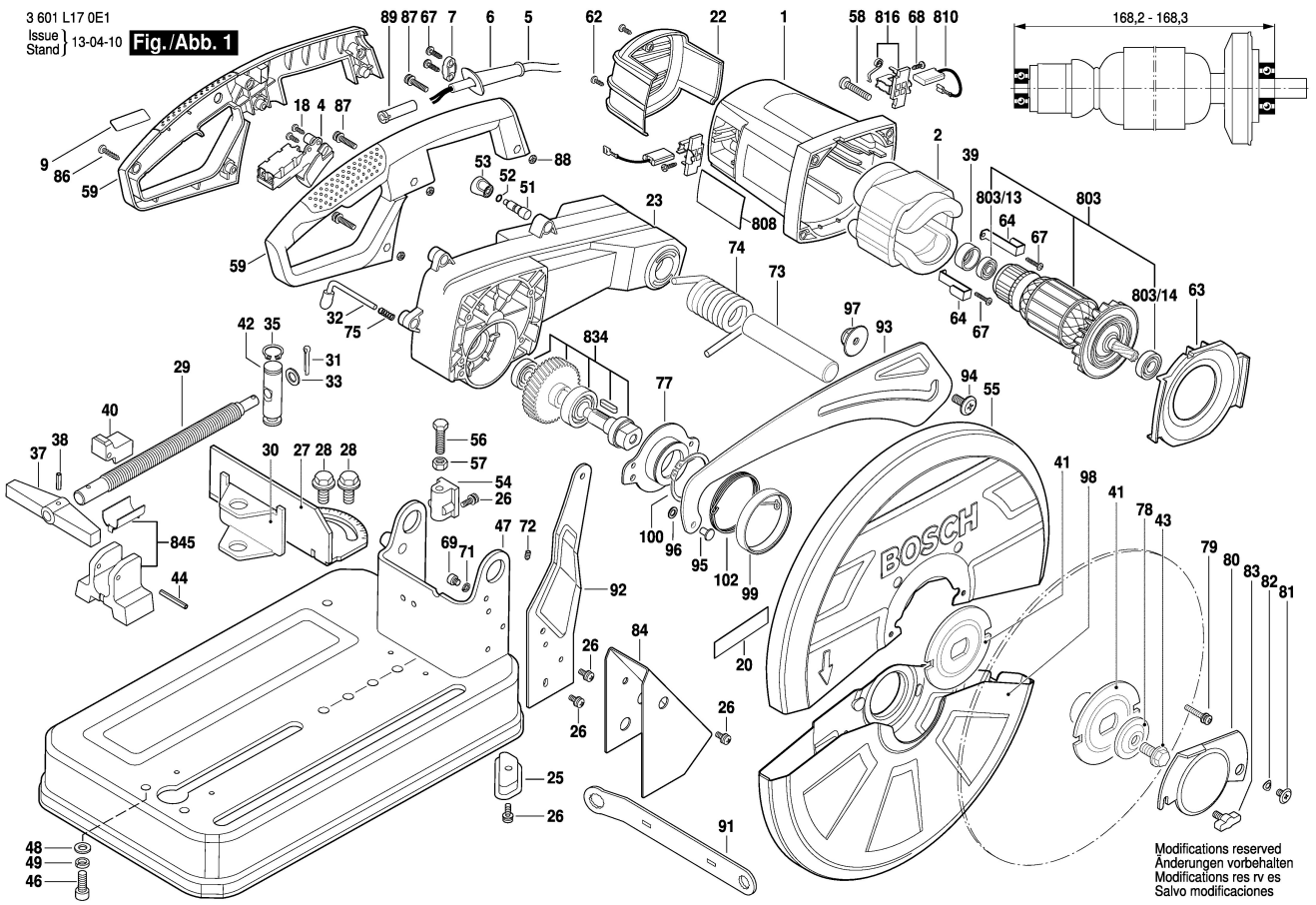

Modifications reserved
Änderungen vorbehalten
Modifications réservés
Salvo modificaciones