

3 603 C40 000
 Stand 10-03-26
 Issue J

Fig./Abb. 1

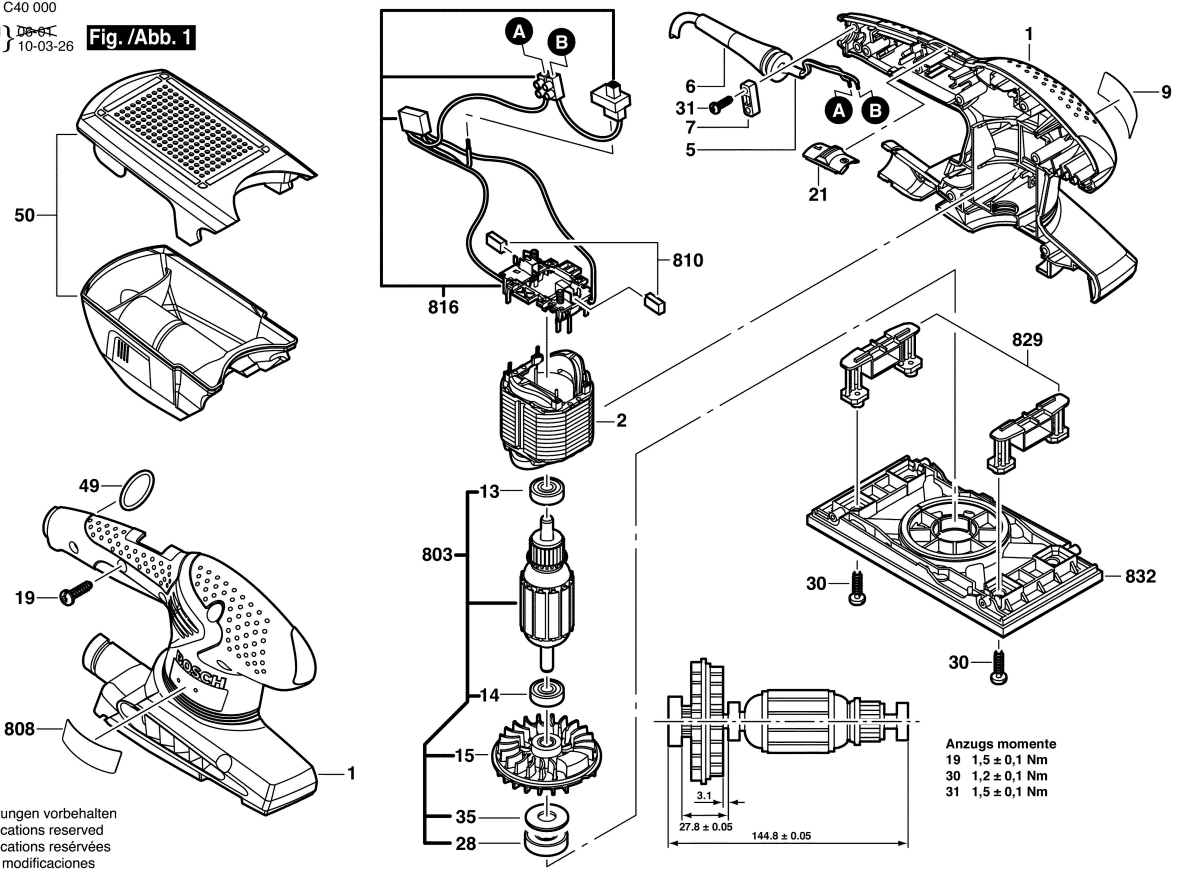

Änderungen vorbehalten
 Modifications reserved
 Modifications réservées
 Salvo modificaciones