

3 611 C35 010  
 Issue } 14-09-15  
 Stand }

**Fig./Abb. 1**

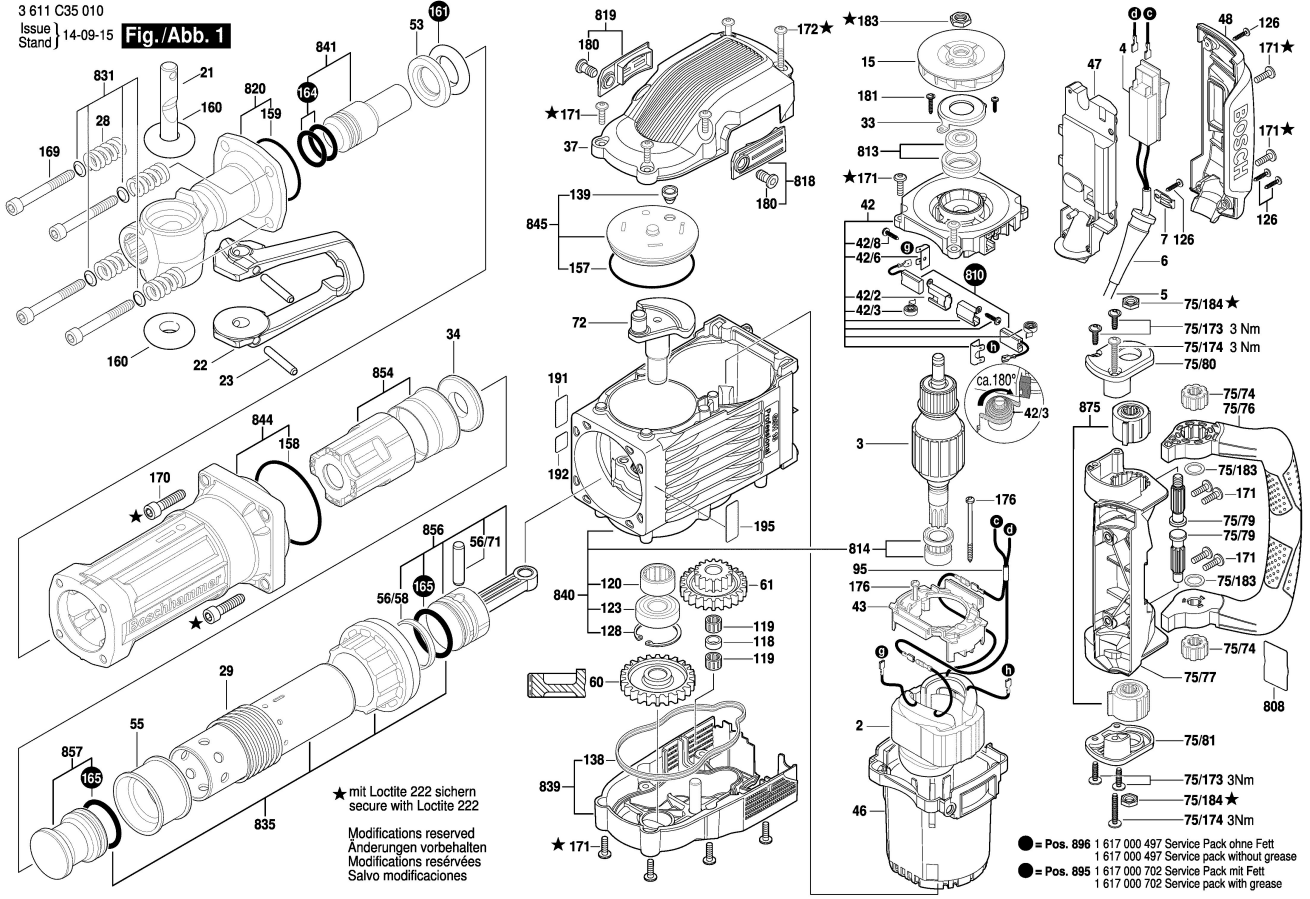

3 611 C35 010  
 Issue } 14-09-15  
 Stand }

**Fig./Abb. 2**

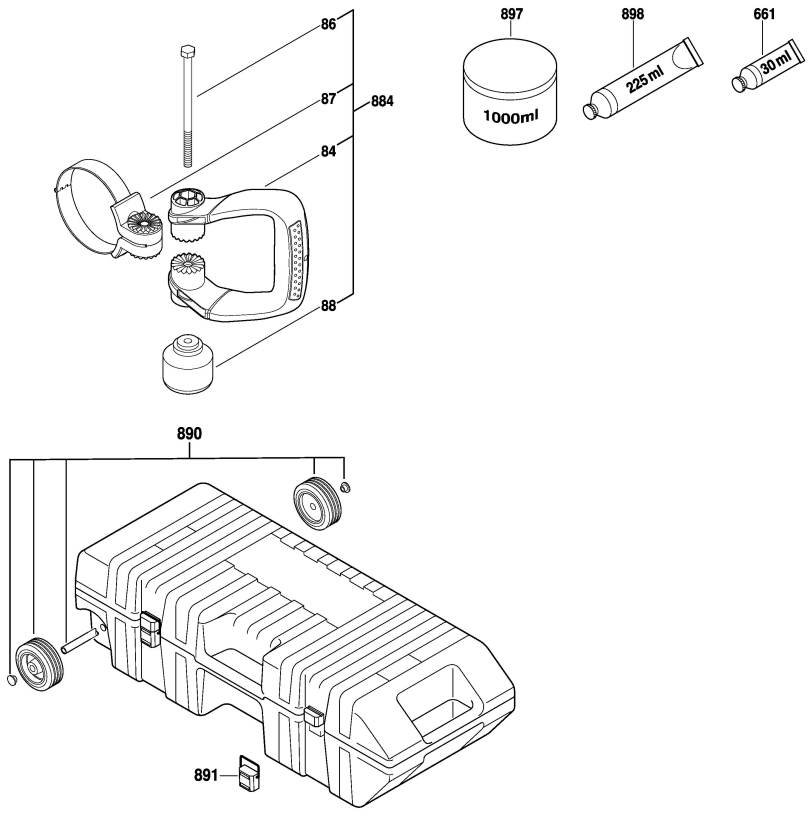

Modifications reserved  
 Änderungen vorbehalten  
 Modifications réservées  
 Salvo modificaciones