

Type: DSke 658-1 (50Hz, 220V)
Part no.: 72022730220

7 202 27 - DSke 658 - 1

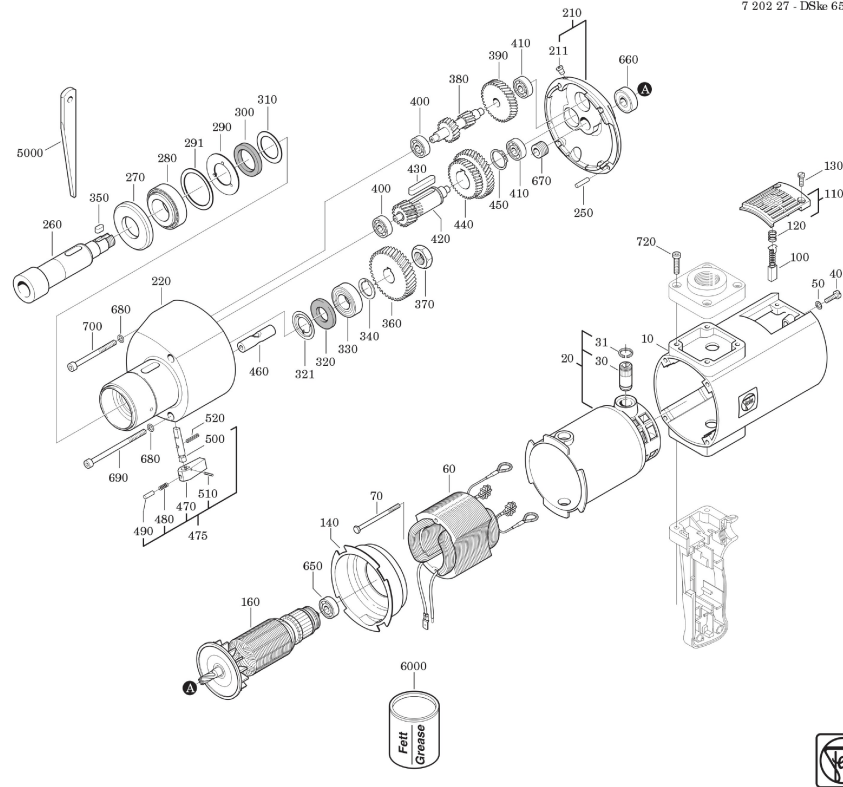

Type: DSke 658-1 (50Hz, 220V)
Part no.: 72022730220

7 202 27 - DSke 658 - 1

