

Type: DDSk 672-1 (60Hz, 110V)
Part no.: 72050113113

7 205 01 - DDSk 672-1

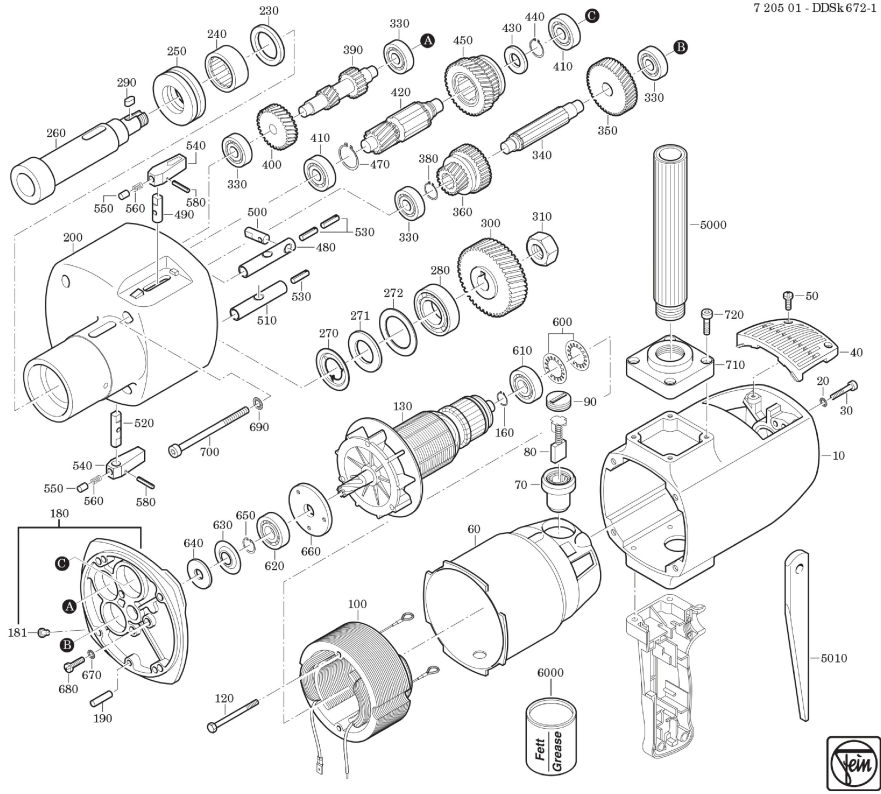

Type: DDSk 672-1 (60Hz, 110V)
Part no.: 72050113113

7 205 01 - DDSk 672-1

