

Type: DDSk 672-1 (50/60Hz, 220/230V)
Part no.: 72050131620

7 205 01 - DDSk 672-1

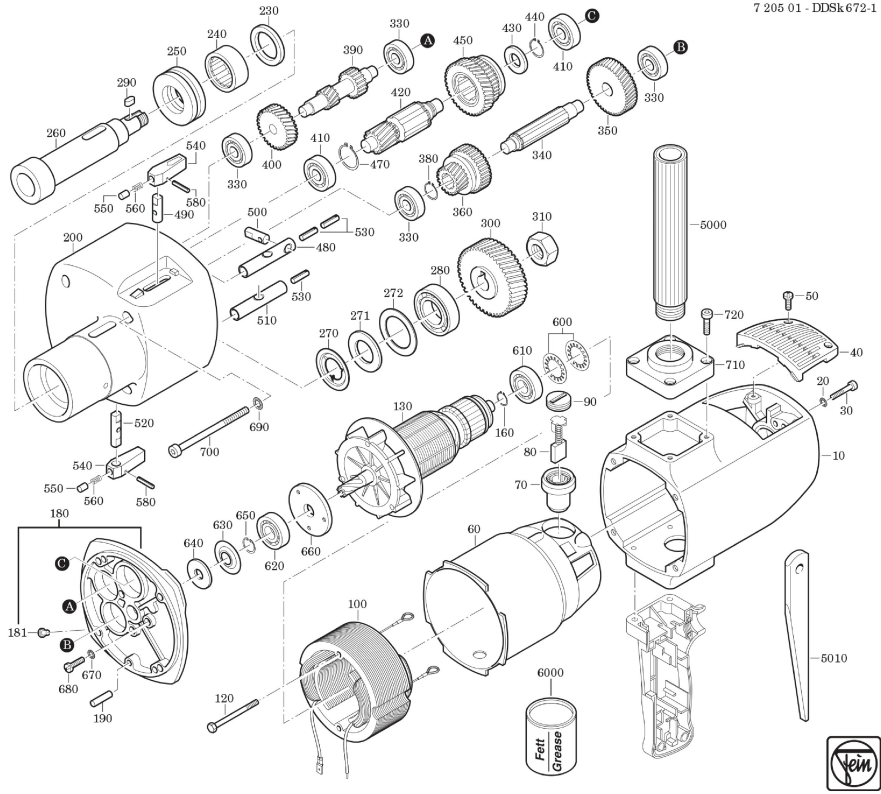

Type: DDSk 672-1 (50/60Hz, 220/230V)
Part no.: 72050131620

7 205 01 - DDSk 672-1

