

Type: ASq 672-1 (50Hz, 240V)
Part no.: 72050300242

7 205 03 - ASq 672-1

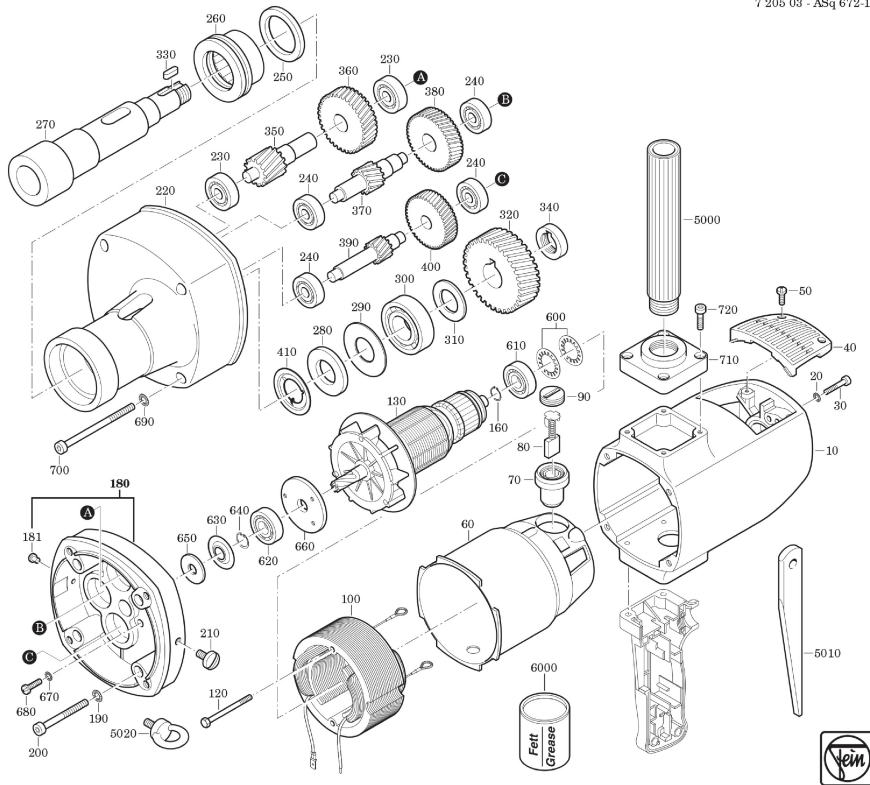

Type: ASq 672-1 (50Hz, 240V)
Part no.: 72050300242

7 205 03 - ASq 672-1

