

Type: KBM 32 Q (50Hz, 220V)
Part no.: 72702735220

7 270 27 - KBM 32 Q

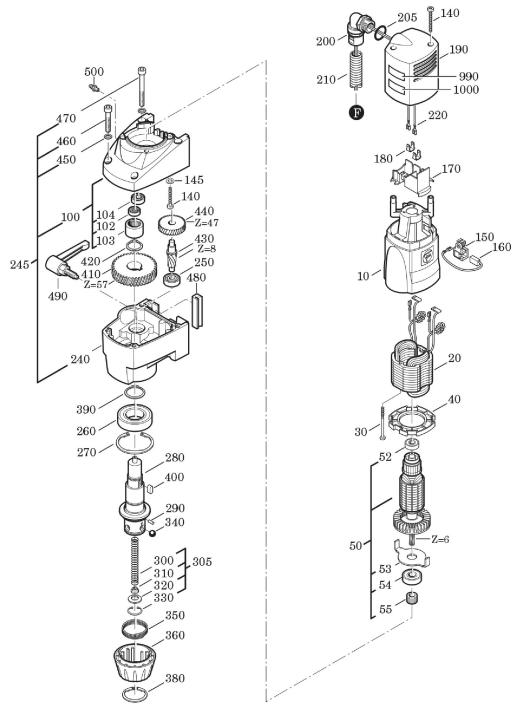

Type: KBM 32 Q (50Hz, 220V)
Part no.: 72702735220

7 270 27 - KBM 32 Q

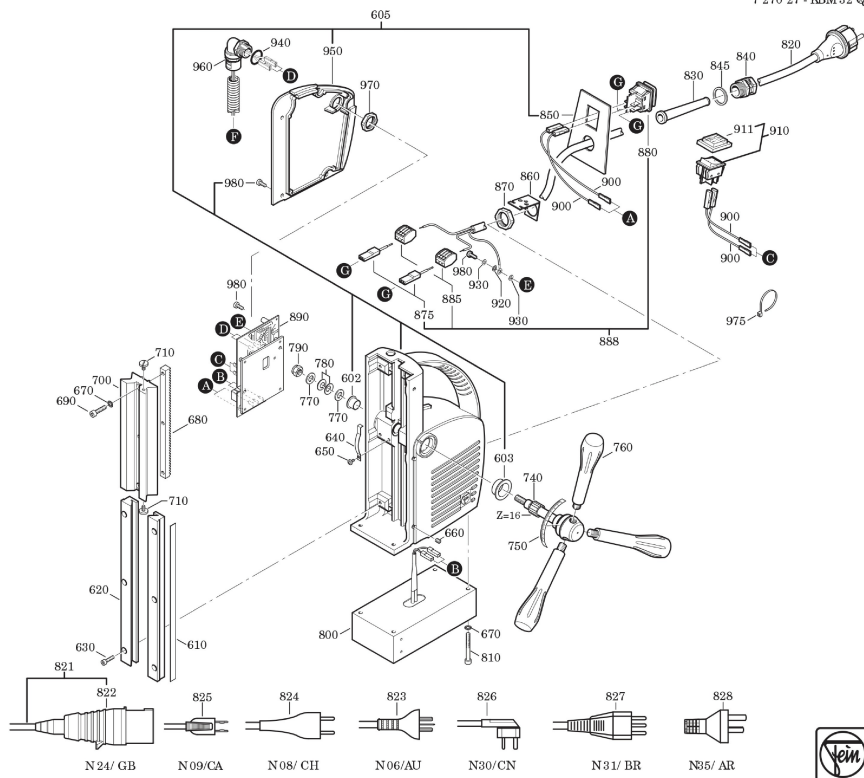

Type:
Part no.:

KBM 32 Q (50Hz, 220V)
72702735220

7 270 27 - KBM32 Q

