

Type:  
Part no.:

JCM 256 U (60Hz, 120V)  
72704712360

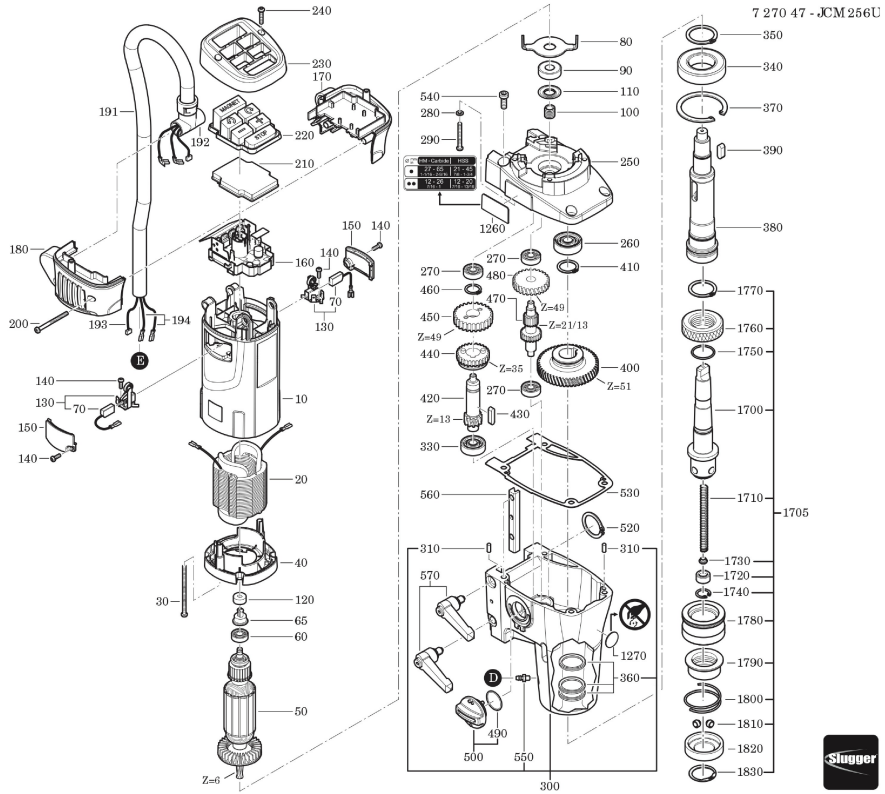

Type:  
Part no.:

JCM 256 U (60Hz, 120V)  
72704712360

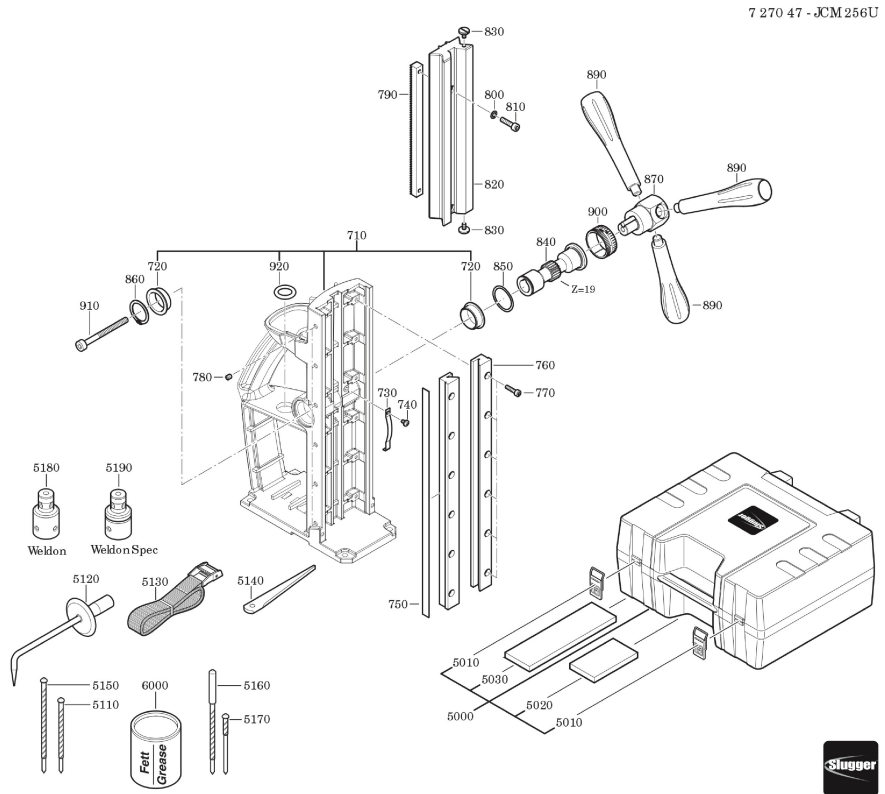

Type:  
Part no.:

JCM 256 U (60Hz, 120V)  
72704712360

7 270 47 - JCM 256U

