

Type: MSfo 869-1c (300Hz, 200V)
Part no.: 78206209260

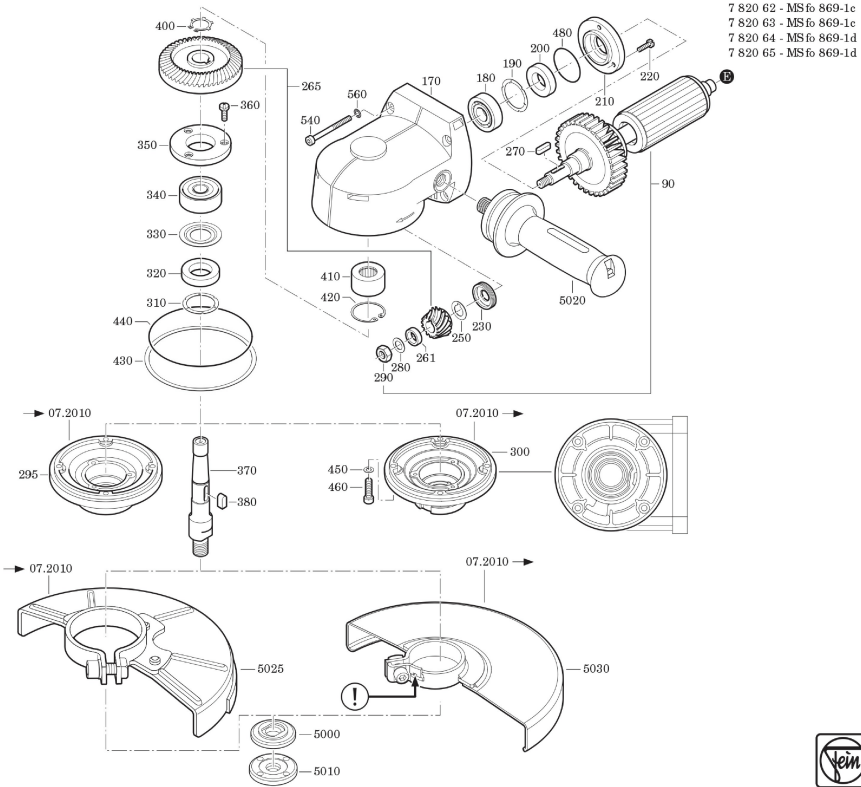

Type: MSfo 869-1c (300Hz, 200V)
Part no.: 78206209260

