

Type: MSfo 869-1c (300Hz, 200V)
Part no.: 78206212260

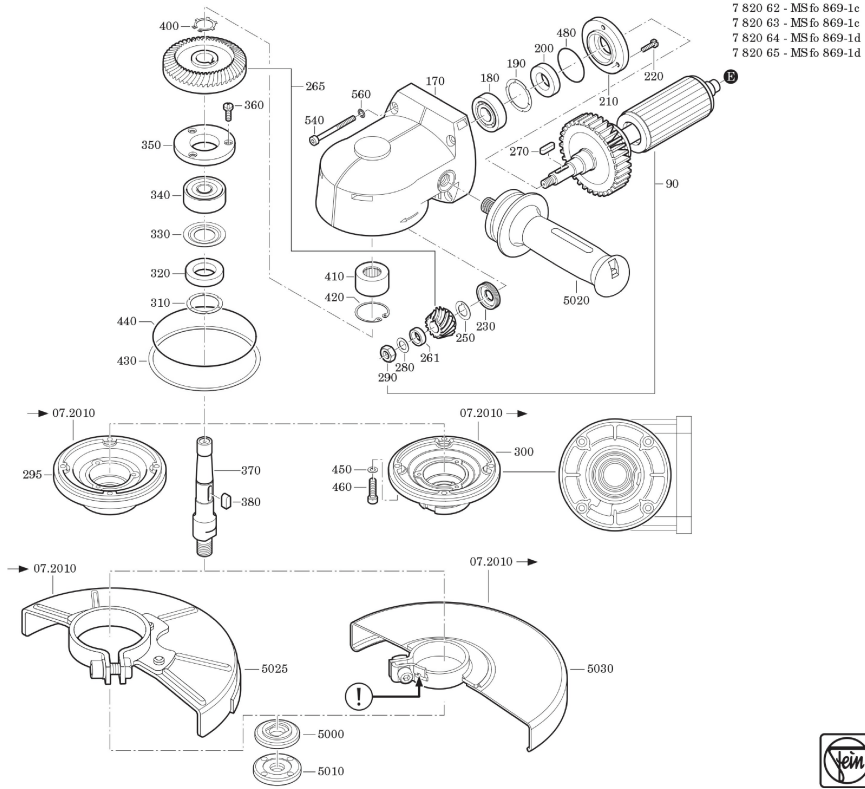

Type: MSfo 869-1c (300Hz, 200V)
Part no.: 78206212260

