

Type:
Part no.:

MSfo 869-1c (200Hz, 72V)
78206300120

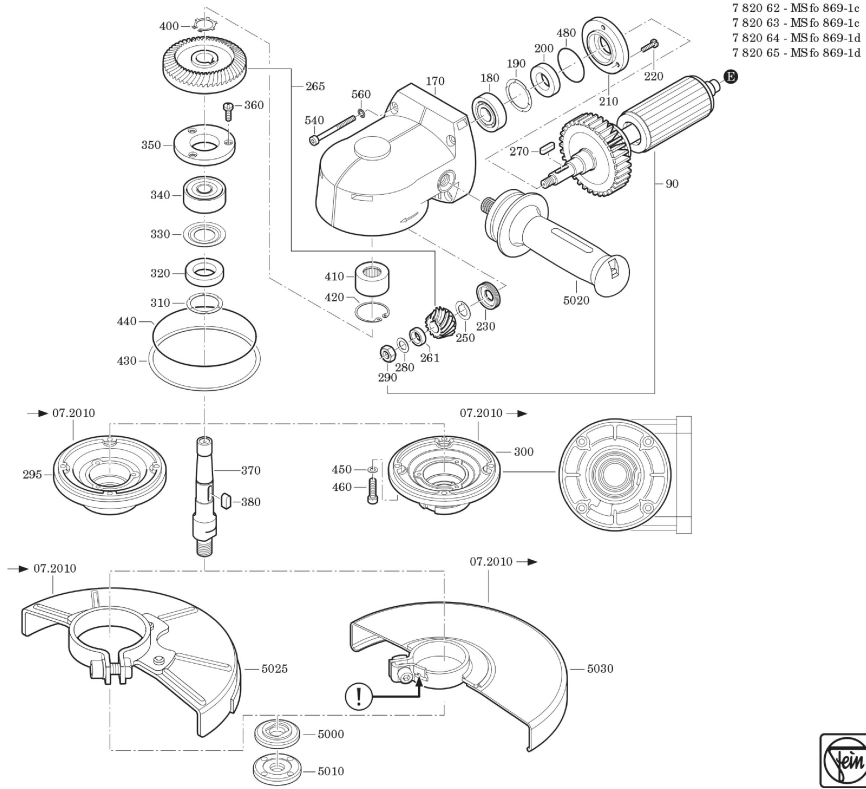

Type:
Part no.:

MSfo 869-1c (200Hz, 72V)
78206300120

