

Type: MSfo 869-1c (200Hz, 265V)
Part no.: 78206300200

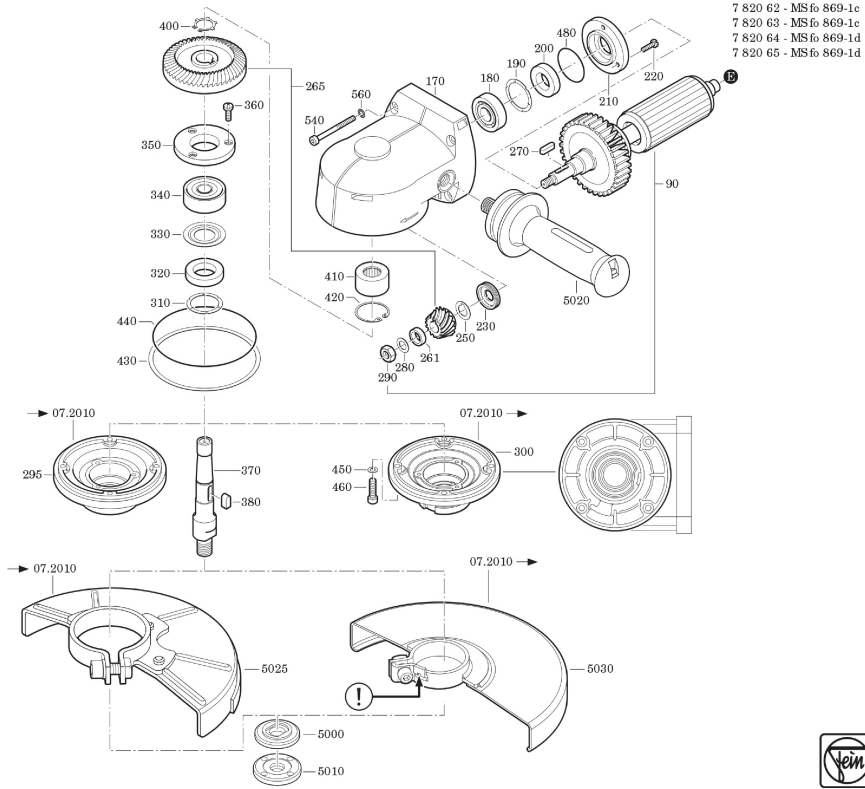

Type: MSfo 869-1c (200Hz, 265V)
Part no.: 78206300200

