

**Type:** MSfo 869-1d (200Hz, 72V)  
**Part no.:** 78206400120

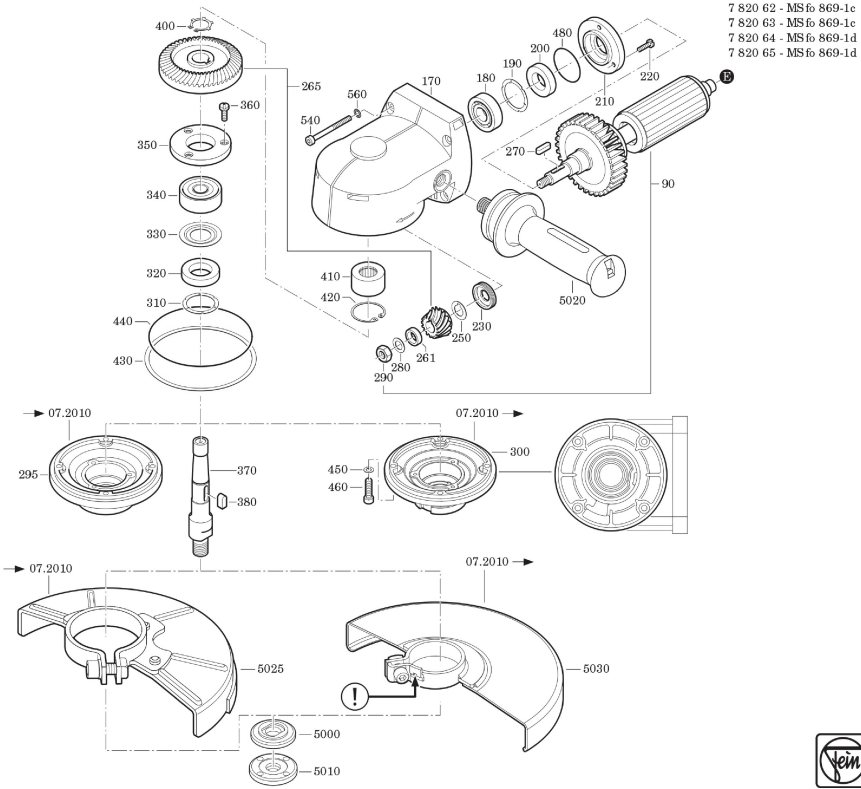

**Type:** MSfo 869-1d (200Hz, 72V)  
**Part no.:** 78206400120

