

**Type:** MSfo 869-1d (200Hz, 265V)  
**Part no.:** 78206400200

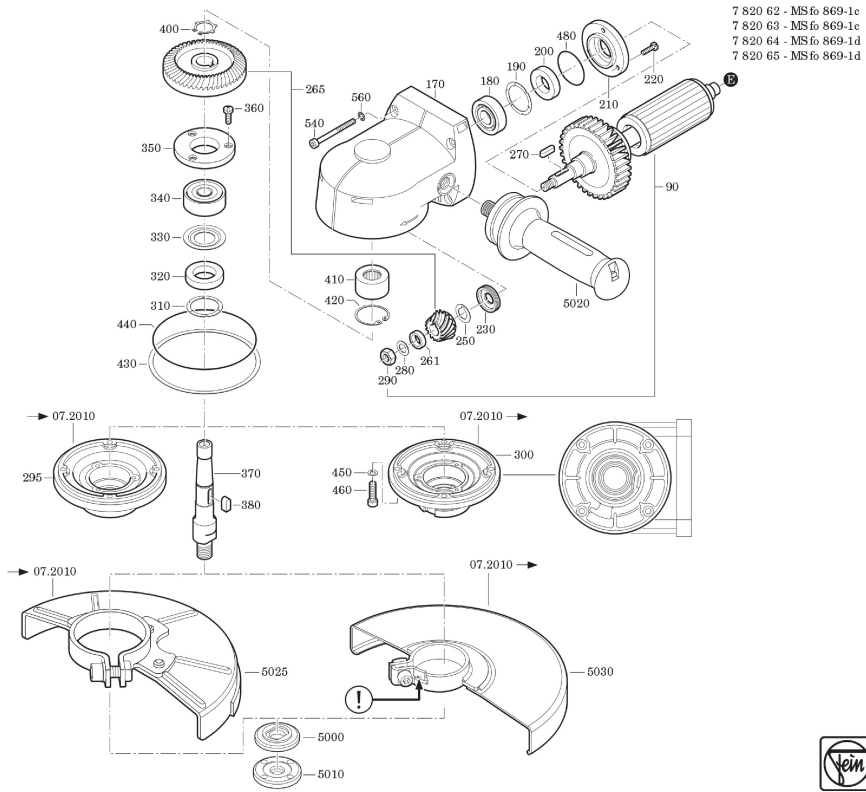

**Type:** MSfo 869-1d (200Hz, 265V)  
**Part no.:** 78206400200

