

**Type:** MSfo 870-1c (200Hz, 265V)  
**Part no.:** 78207400200

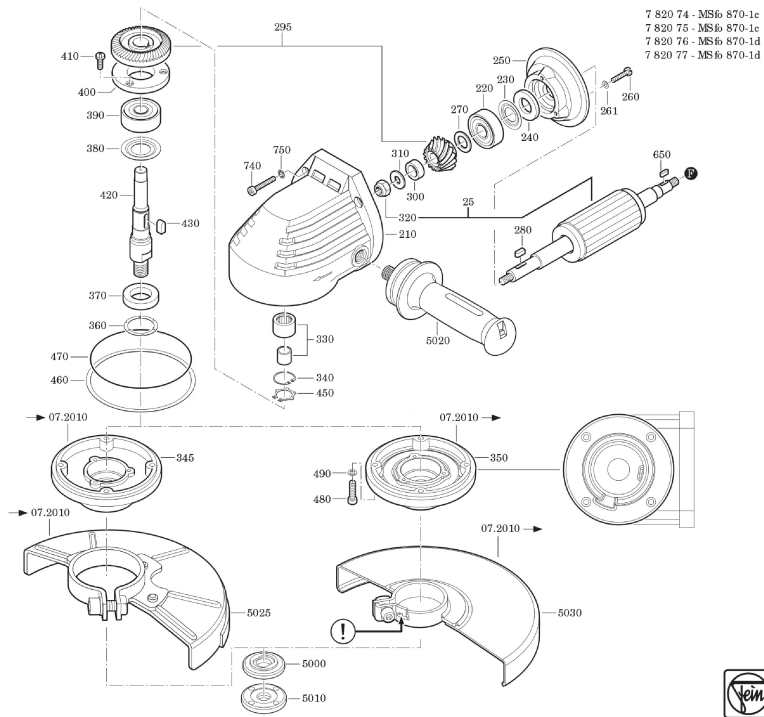

**Type:** MSfo 870-1c (200Hz, 265V)  
**Part no.:** 78207400200

