

Type: MSfo 870-1d (200Hz, 135V)
Part no.: 78207600170

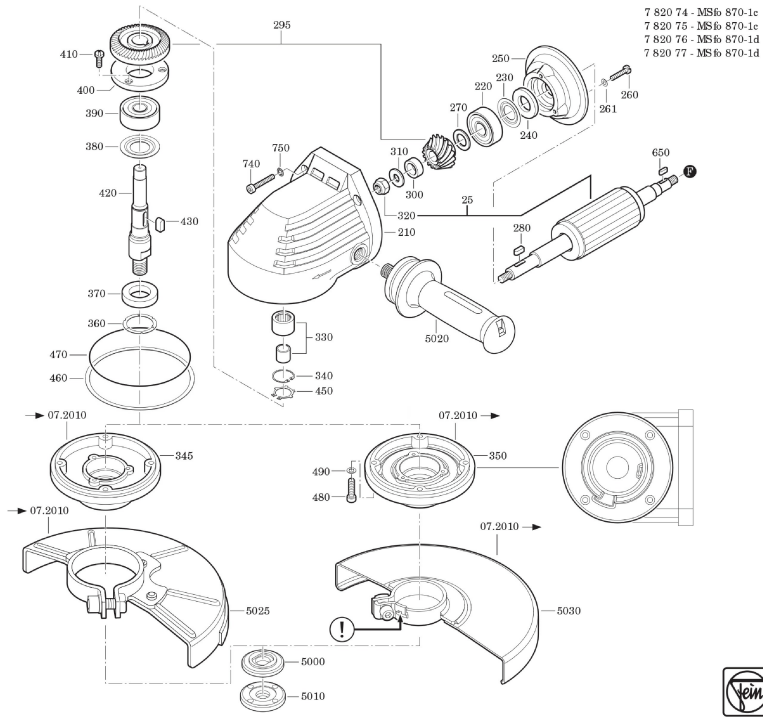

Type: MSfo 870-1d (200Hz, 135V)
Part no.: 78207600170

