

Type:
Part no.:

MSfo 870-1d (300Hz, 200V)
78207709260

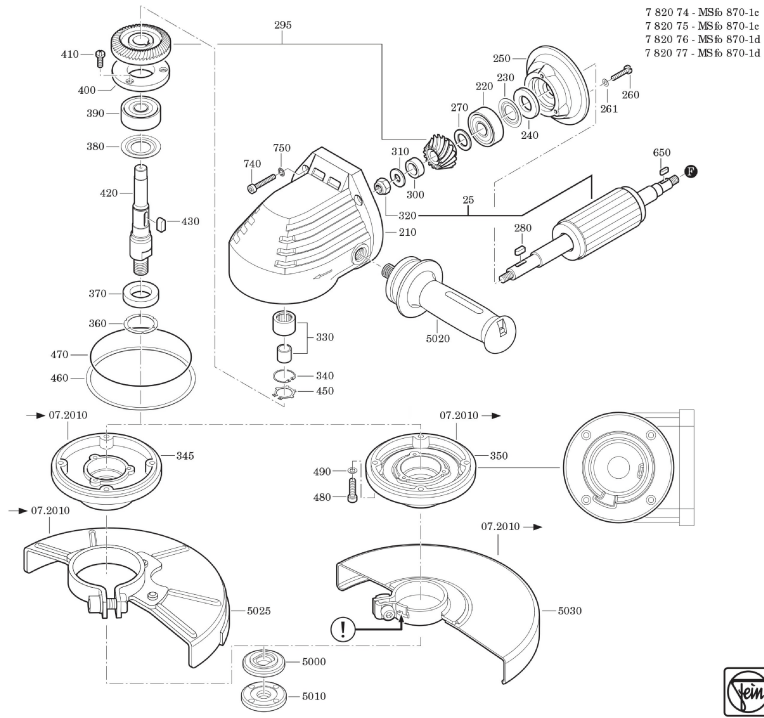

Type:
Part no.:

MSfo 870-1d (300Hz, 200V)
78207709260

