

Type: MSfo870-1d (300Hz, 200V)
Part no.: 78207712260

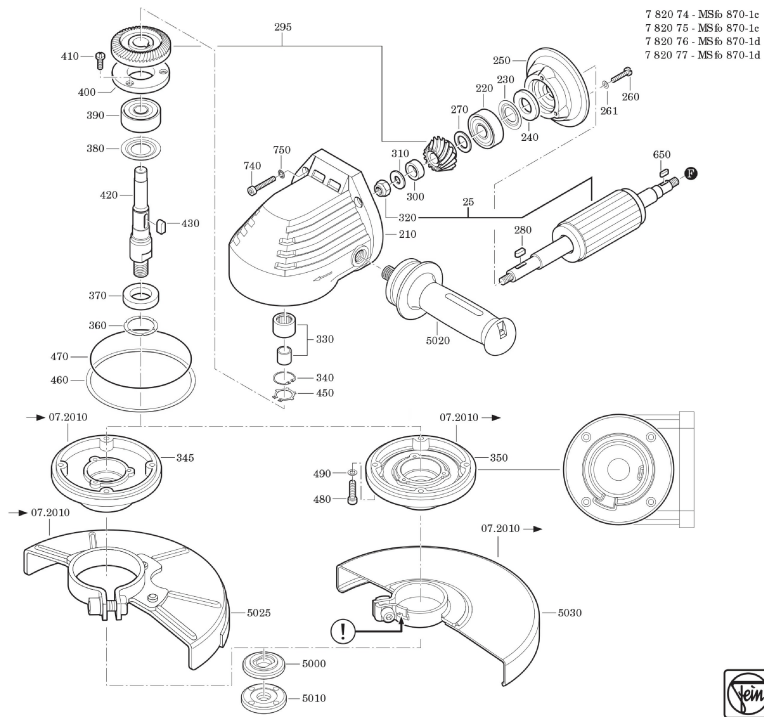

Type: MSfo870-1d (300Hz, 200V)
Part no.: 78207712260

