

**Type:** MSfo 849-1c (200Hz, 265V)  
**Part no.:** 78207900200

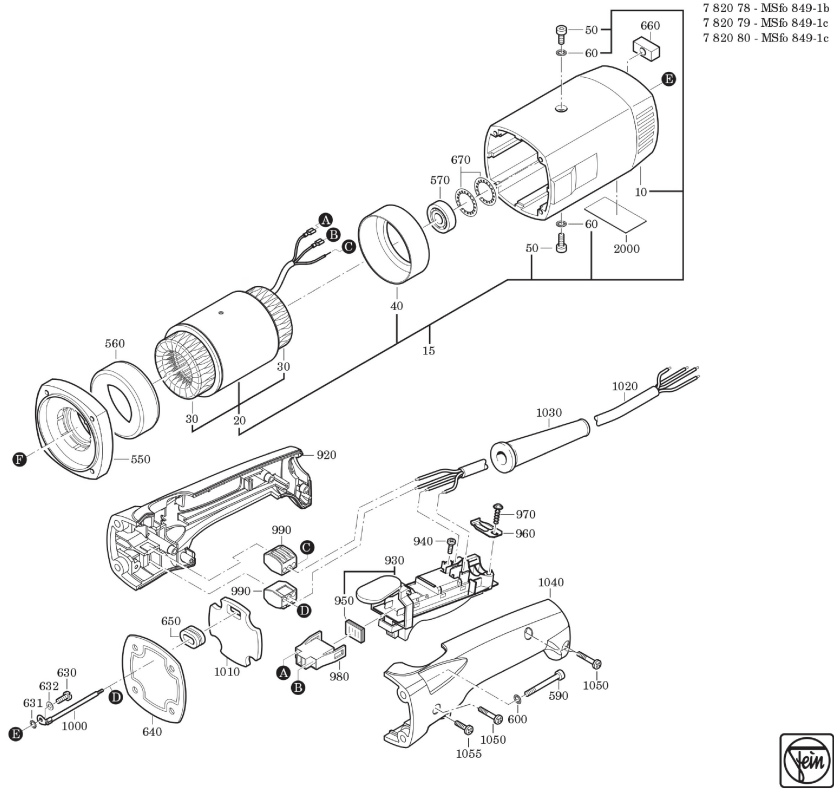

**Type:** MSfo 849-1c (200Hz, 265V)  
**Part no.:** 78207900200

