

Type: MSf 843-1c (300Hz, 200V)
Part no.: 78208595260

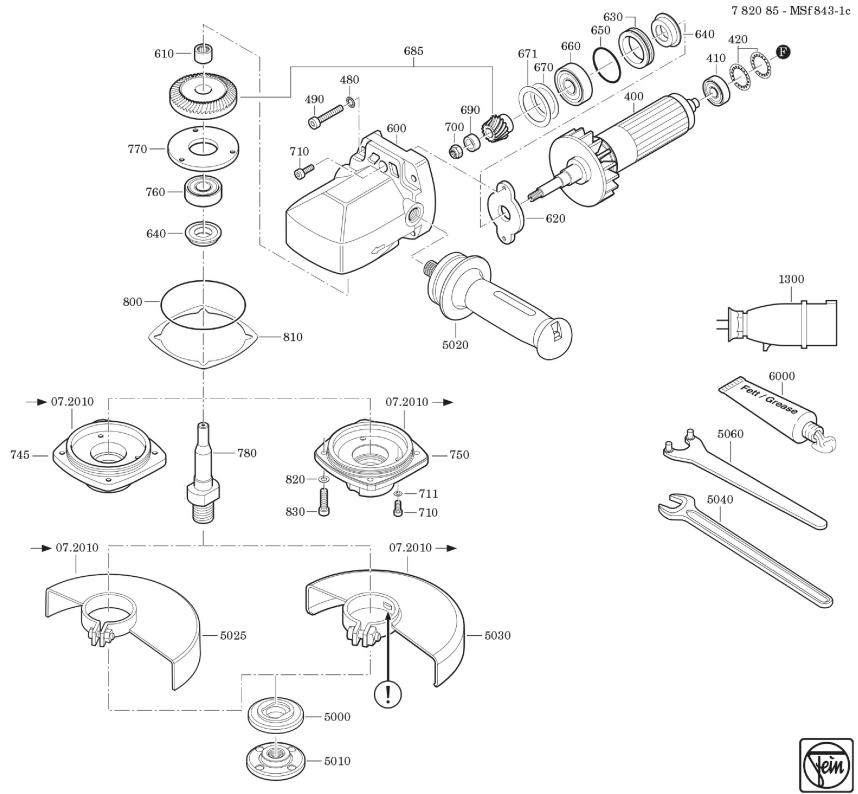

Type: MSf 843-1c (300Hz, 200V)
Part no.: 78208595260

