

9 617 082 542

Stand } 01-07-30  
Issue }

**Fig./Abb. 1**

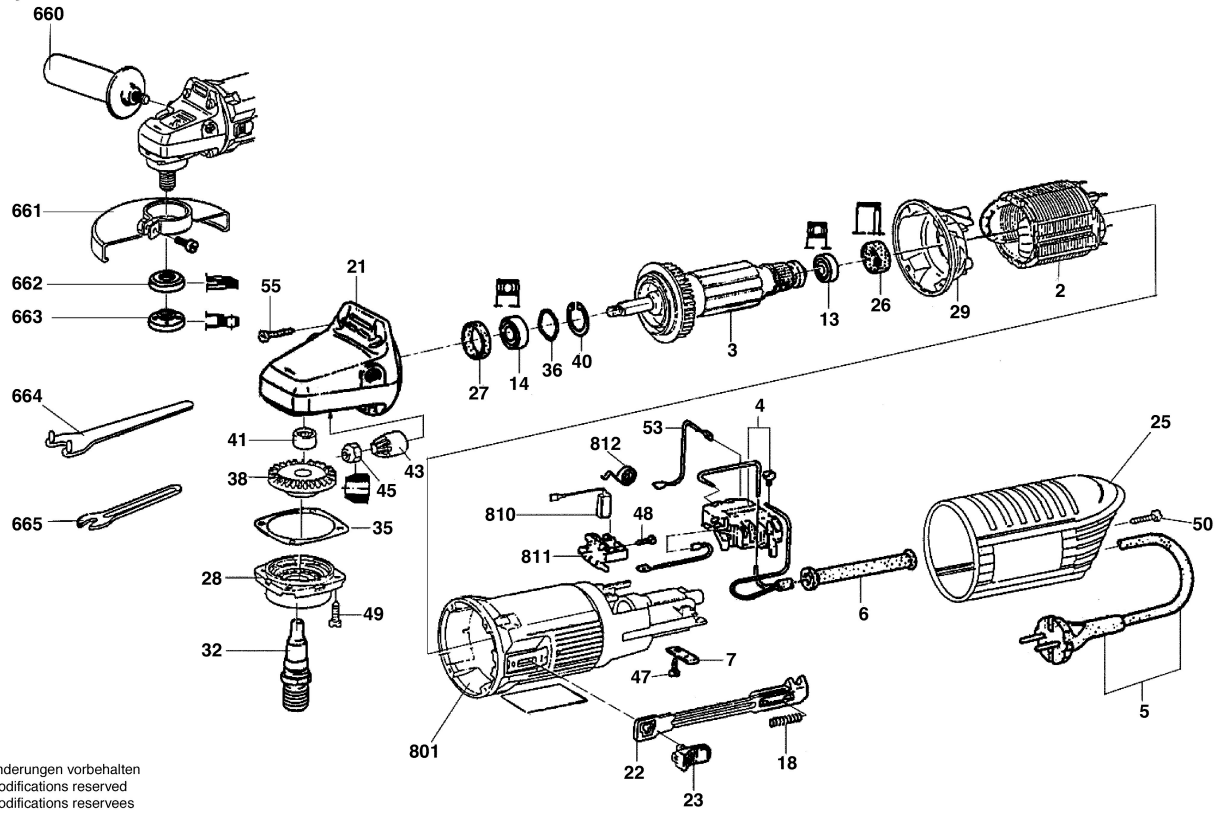

Änderungen vorbehalten  
Modifications reserved  
Modifications reserves  
Salvo modificaciones