

F012 140 000
Issue 11-02-09
Stand

Fig./Abb. 1

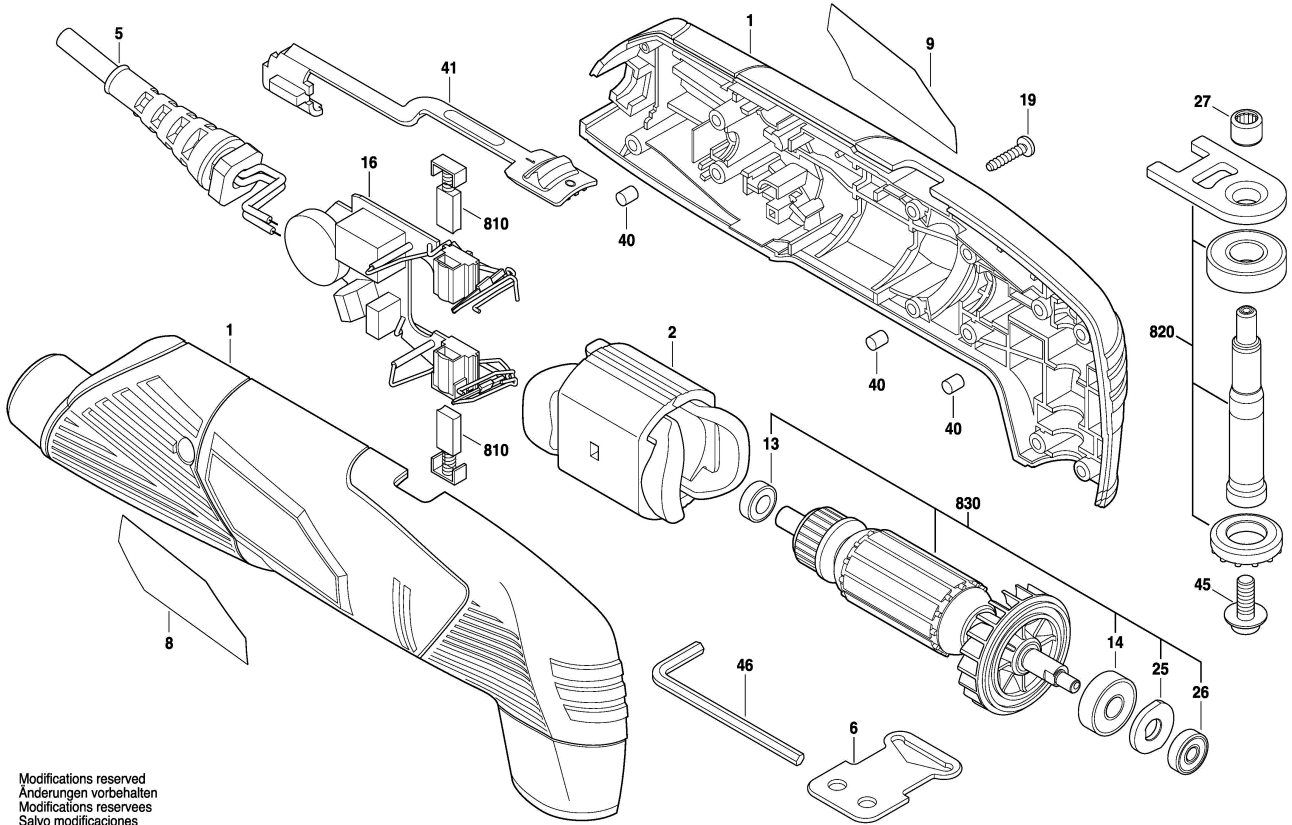

Modifications reserved
Änderungen vorbehalten
Modifications reserves
Salvo modificaciones