

F 012 234 602

Stand } 08-10-14 **Abb./Fig. 1**
Issue }

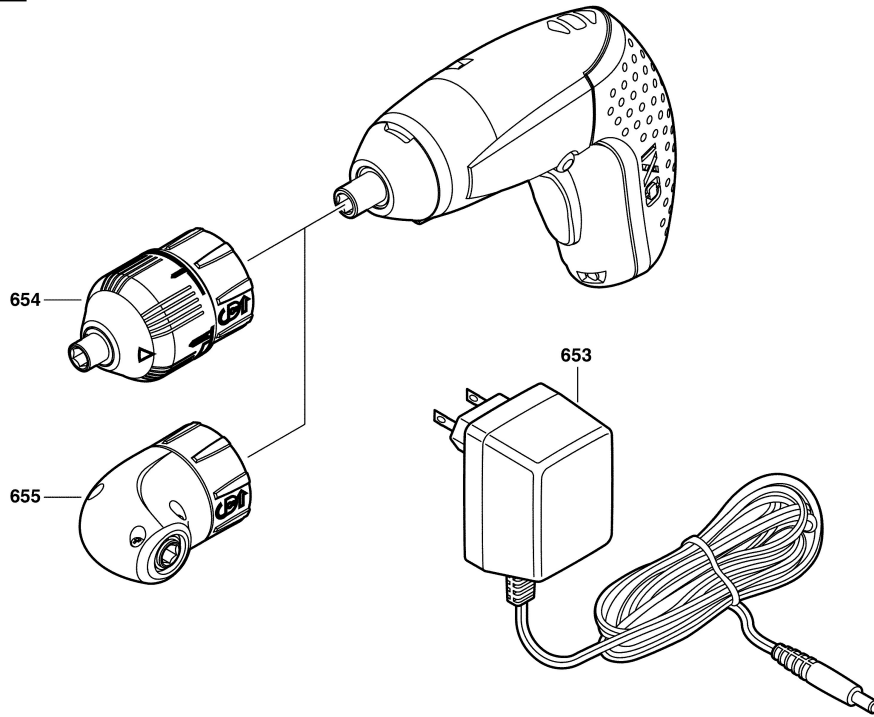

Änderungen vorbehalten
Modifications reserved
Modifications reserves
Salvo modificaciones