

F 012 235 000

Stand } 09-09-23 **Abb./Fig. 1**  
Issue }

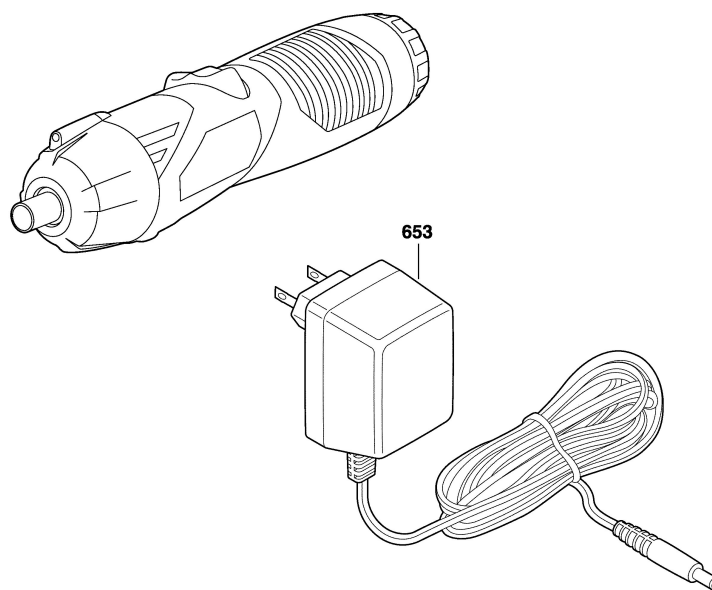

Änderungen vorbehalten  
Modifications reserved  
Modifications reserves  
Salvo modificaciones