

F 012 246 600
Stand 1 07-10-05
Issue J 04-10-20

Fig./Abb. 1

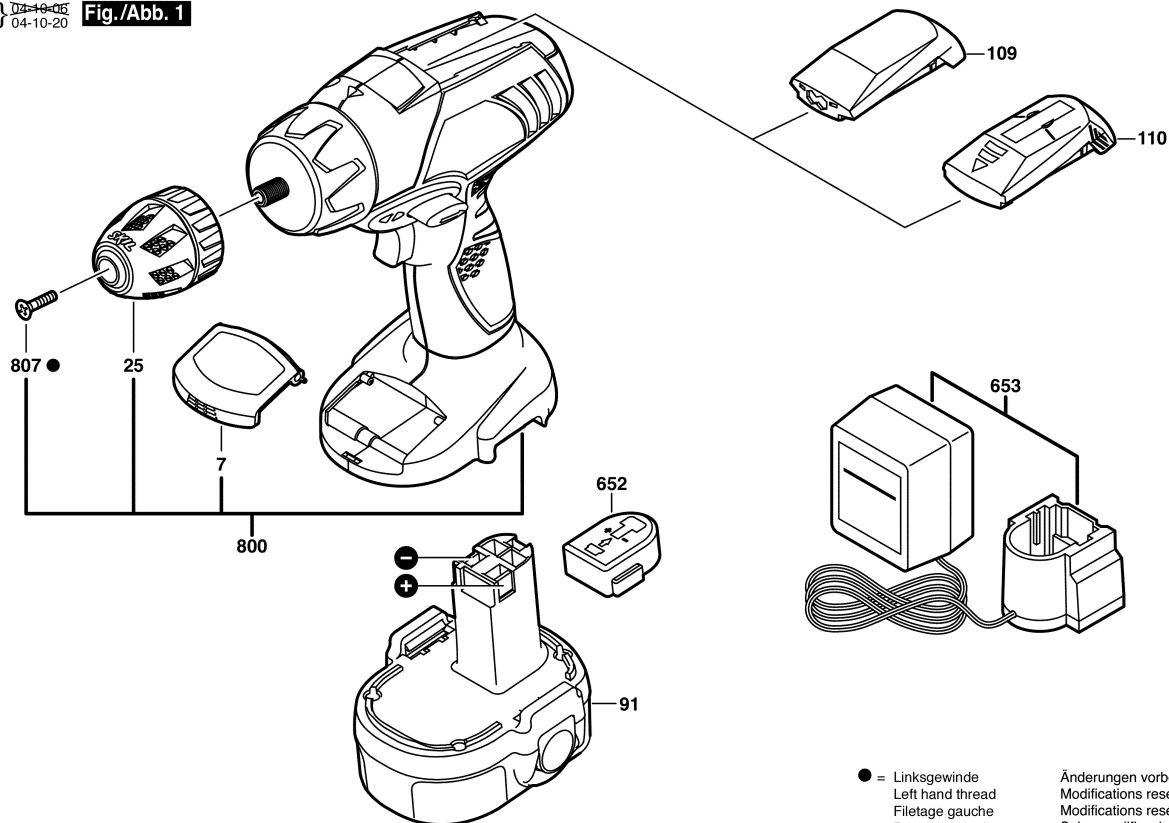

● = Linksgewinde
Left hand thread
Filetage gauche
Rosca izquierda

Änderungen vorbehalten
Modifications reserved
Modifications réservées
Salvo modificaciones