

F012247502

Stand Issue J 00-06-02

Fig./Abb. 1

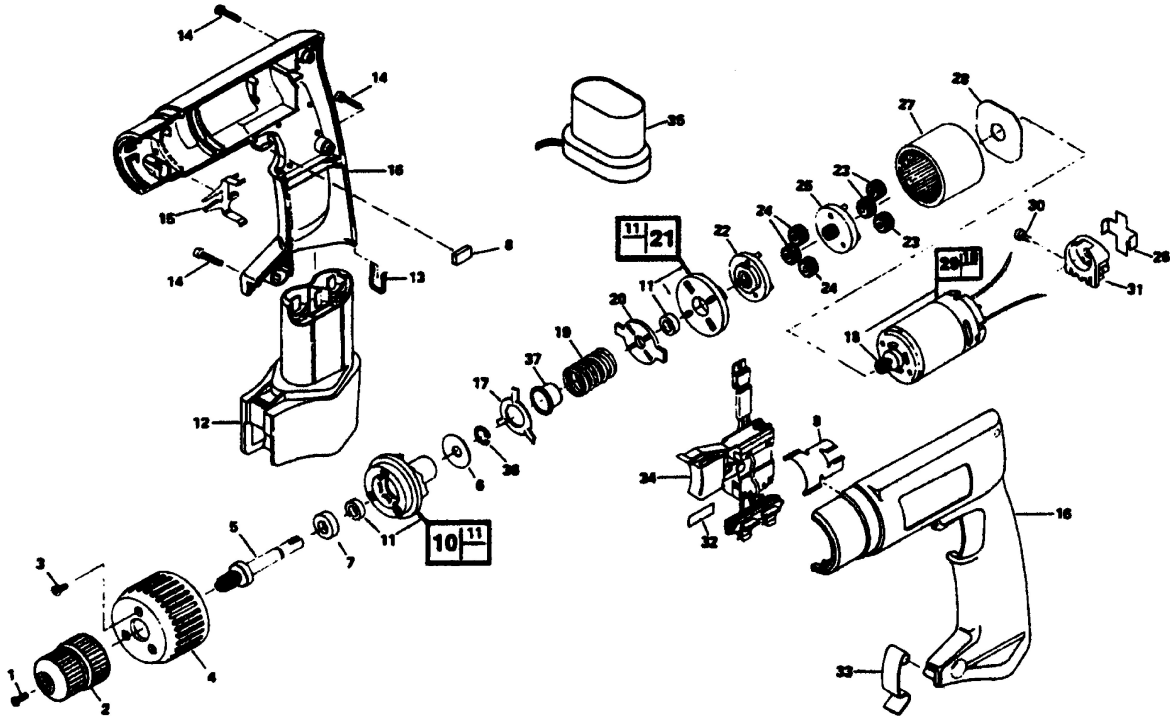

Änderungen vorbehalten
Modifications reserved
Modificaciones reservadas
Salvo modificaciones