

F012 289 000
Issue
Stand

04-06-10 **Fig./Abb. 1**

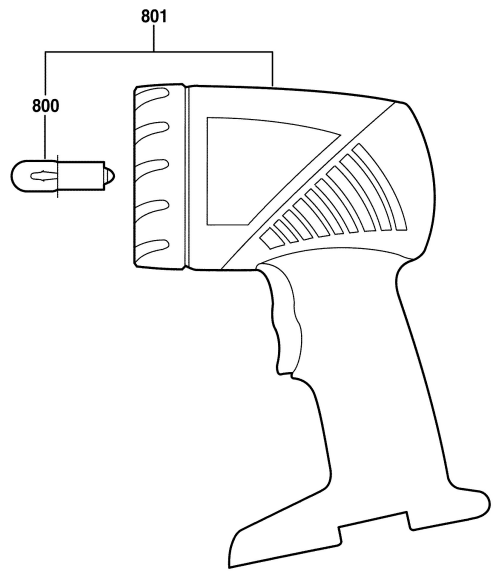

Modifications reserved
änderungen vorbehalten
Modifications réservés
Salvo modificaciones