

F012 238 002
Issue | 00-11-03
Stand |

Fig./Abb. 1

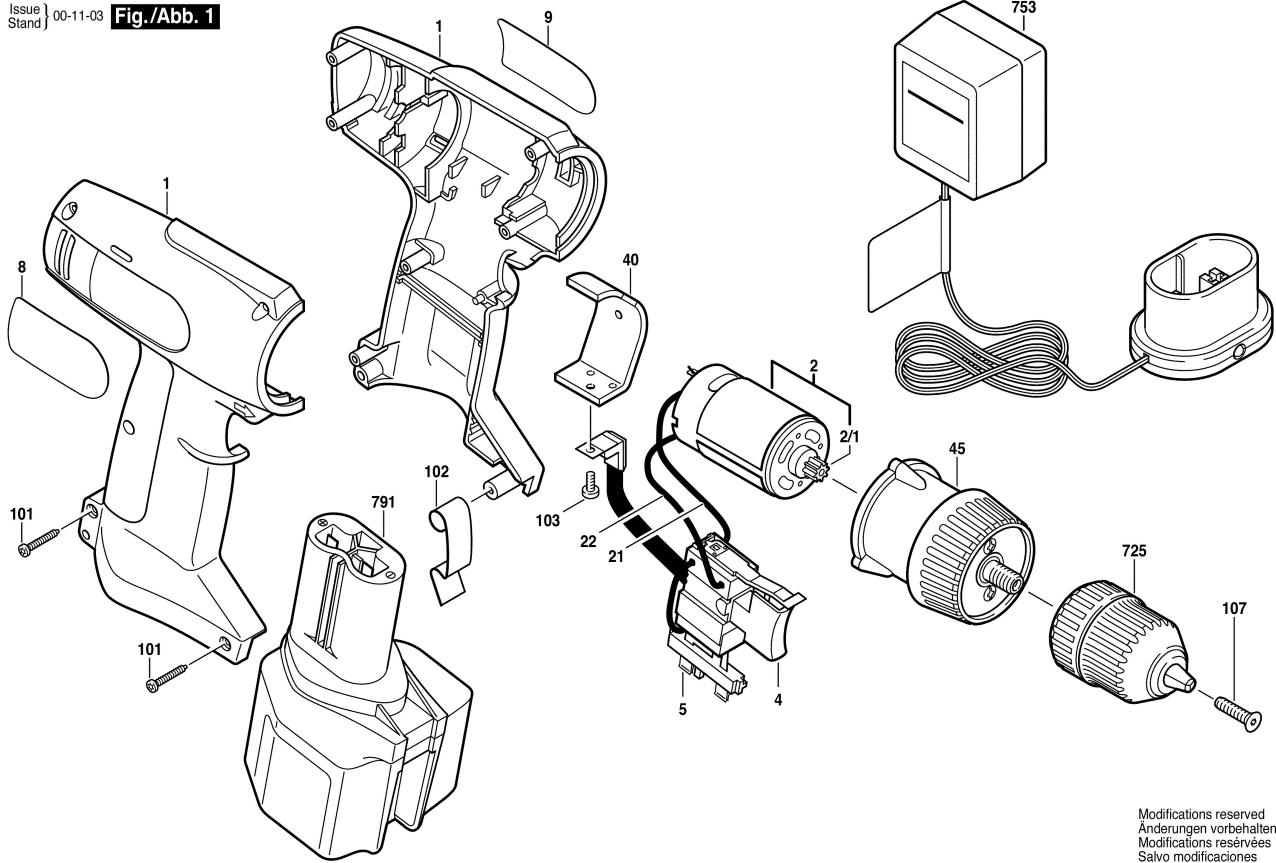

Modifications reserved
Änderungen vorbehalten
Modifications réservées
Salvo modificaciones