

F 012 261 223

Stand } 13-01-18 **Fig. /Abb. 1**

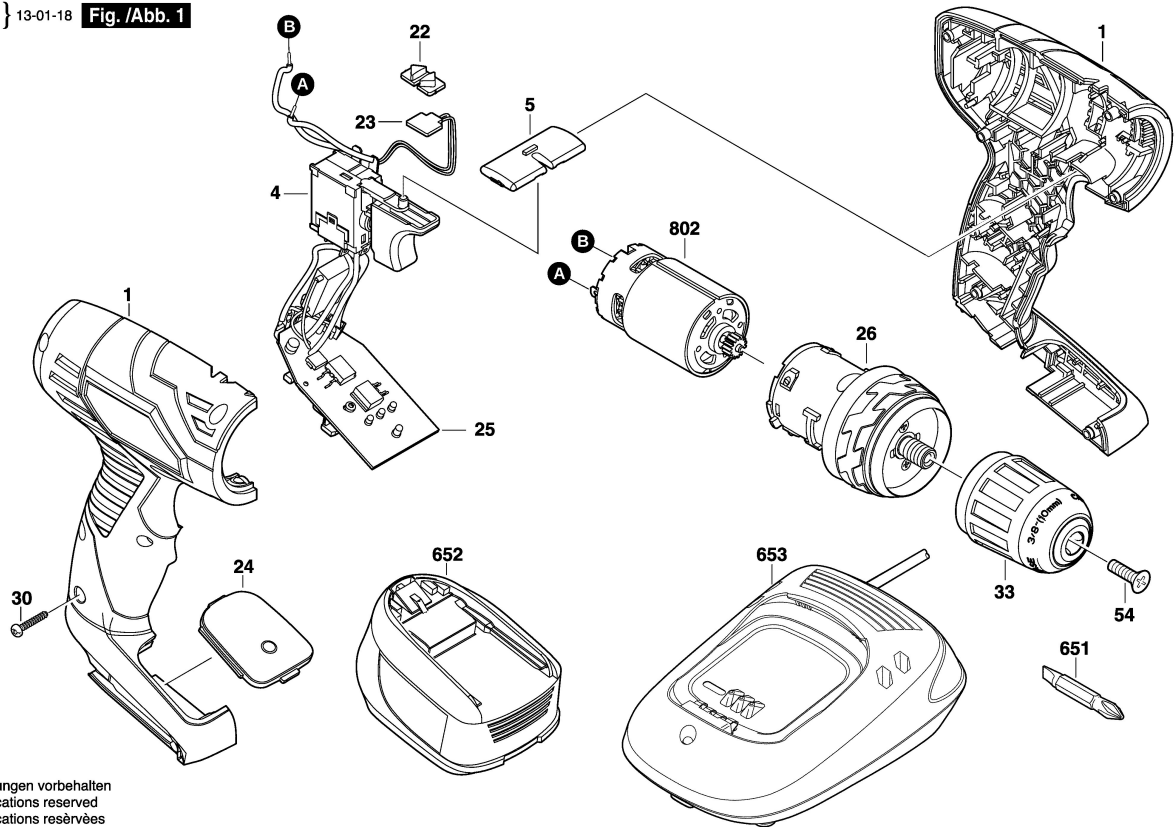

Änderungen vorbehalten
Modifications reserved
Modifications réservées
Salvo modificaciones