

F 012 300 000

Stand | 10-03

Issue | 12-11-26

Abb./Fig. 1

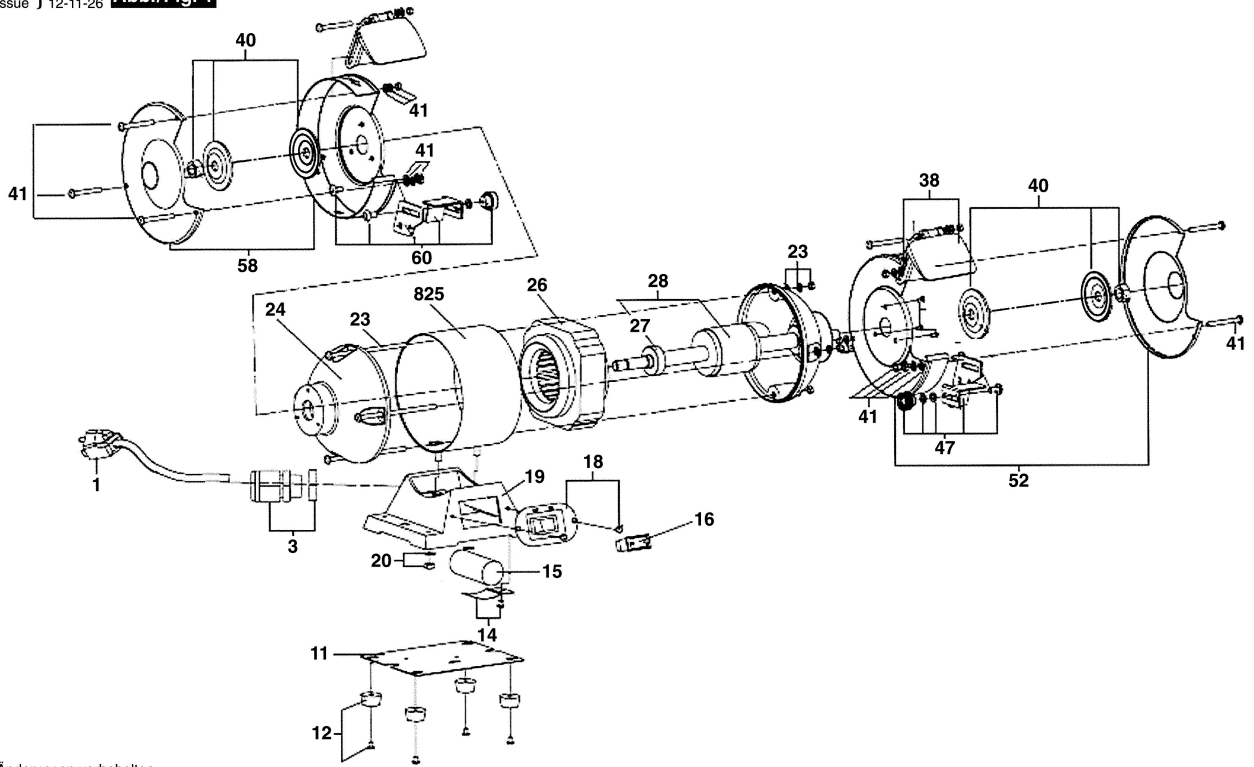

Änderungen vorbehalten
Modifications reserved
Modifications reserves
Salvo modificaciones