

F 012 300 045

Stand | 11-11
Issue | 12-11-26

Abb./Fig. 1

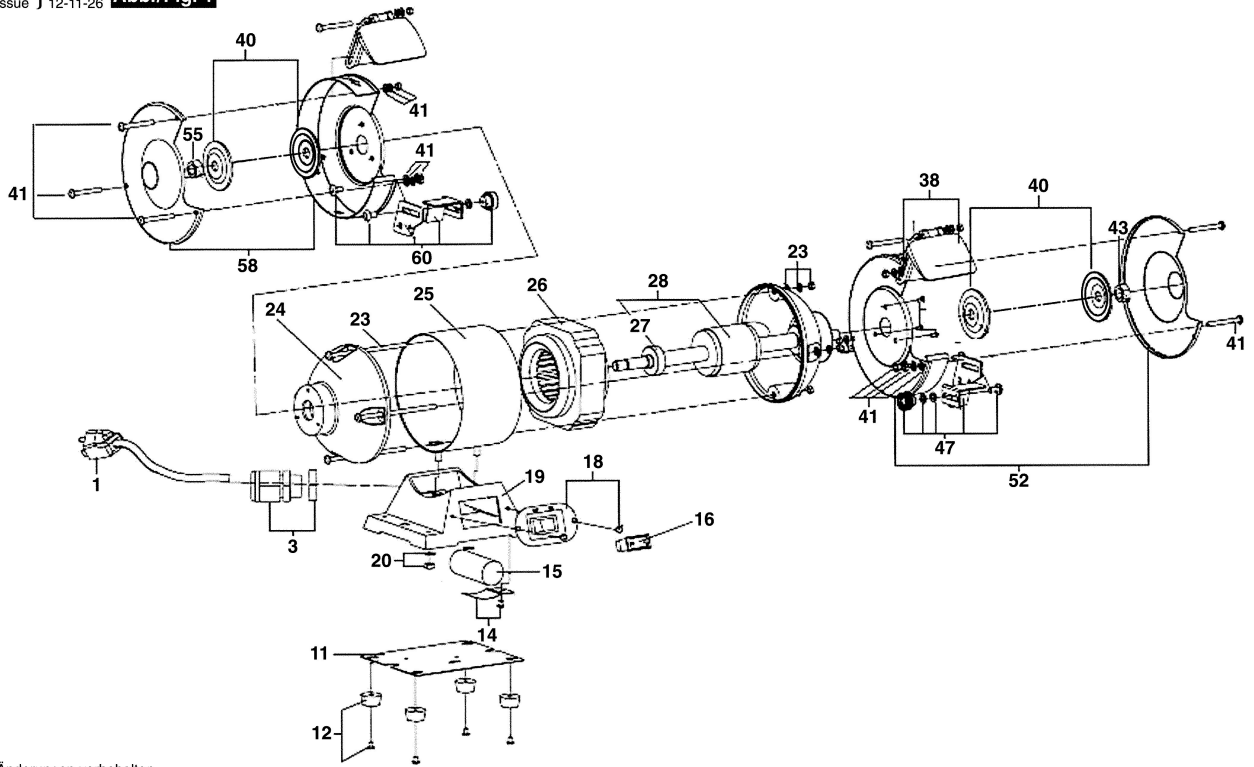

Änderungen vorbehalten
Modifications reserved
Modifications reserves
Salvo modificaciones